

NIKKEN

NIKKEN BORING SYSTEM

ZMAC-V eMAC DJ RAC BAC



E

NIKKEN KOSAKUSHO WORKS, LTD.
CAT.NO.9922



NIKKEN KOSAKUSHO WORKS, LTD. OSAKA, JAPAN.

5-1, 1-chome, Minamishinden, Daito-shi, Osaka-fu, Japan. Telephone:072-869-5820 Telefax:072-869-6220

U.S.A CA, CT, IL, NC, TX, WA

LYNDEX-NIKKEN
1468 Armour Boulevard,
Mundelein, ILLINOIS 60060
Tel.+1-847-367-4800 Fax.+1-847-367-4815

MEXICO (From 2014.09)

HERRAMIENTAS LYNDEX-NIKKEN S.A.de C.V.
Av. Hercules #401-13, Fracc. Poligono 3
Santa Rosa Jauregui, Queretaro 76220
Tel.+52-55-8421-8421

FRANCE

PROCOMO-NIKKEN S.A.S
6, avenue du 1er Mai-Z.A.E.Les Glaises 91127
Palaiseau Cedex
Tel.+33-(0)-1-69.19.17.35 Fax.+33-(0)-1-69.30.64.68

UK

NIKKEN KOSAKUSHO EUROPE LTD.
Precision House, Barbot Hall Industrial Estate,
Rotherham, South Yorkshire, S61 4RL
Tel.+44-(0)-1709-366306 Fax.+44-(0)-1709-376683

F.R.GERMANY

NIKKEN DEUTSCHLAND GmbH
Eisenstraße 9c, 65428 Rüsselsheim
Tel.+49-(0)-6142-550600 Fax.+49-(0)-6142-550606

ITALY

VEGA INTERNATIONAL TOOLS S.P.A
Via Asti N-9 10026-Santena(TORINO)
Tel.+39-011-9497911 Fax.+39-011-9456380

SWITZERLAND

NIKKEN SWITZERLAND AG
Chamberstrasse 44 6331 Hunenberg
Tel.+41-(0)-41-748-5000 Fax.+41-(0)-41-748-5001

SCANDINAVIA SWEDEN

NIKKEN SCANDINAVIA AB
Bultgatan 13b, 44240 Kungälv
Tel.+46-(0)-303-440-600 Fax.+46-(0)-303-58177

SPAIN & PORTUGAL

CUTTING TOOL S.L (TOOLING)
PORTUETXE 16, BARRIO IGARRA
E-20018 DONOSTIA-SAN SEBASTIAN
Tel.+34-(0)-902-820090 Fax.+34-(0)-902-820099
NIKKEN EUROPE DIVISORES ESPANA (CNC ROTARY TABLE)
Tel.+34-(0)-669-603433

TURKEY

NIKKEN KESICI TAKIMLAR SAN. VE ULUSLARARASI TIC. A. S
E5 Uzeri Kucukyali Yanyol Irmak Sok.
Kucukyali Sanayi Sitesi A Blok No:5 Maltepe 34852 Istanbul
Tel.+90-(0)-216-518-1010 Fax.+90-(0)-216-366-1414

KOREA

KOREA NIKKEN LTD.
90B-11L, Namdong Industrial Complex, 170, Namdong-Daero,
Namdong-Gu, Incheon, Korea 405-819
Tel.+82-(0)-32-763-4461 Fax.+82-(0)-32-763-4464

P.R.CHINA

SHANGHAI ZHONG YAN TRADING CO., LTD.
BUILDING 1/F, #54, No.1089 QINZHOU RD. (N),
SHANGHAI, CHINA
Tel.+86-(0)-216210-2506 Fax.+86-(0)-216210-2083

SINGAPORE

NIKKEN KOSAKUSHO ASIA PTE, LTD.
268, WOODLANDS CENTRE ROAD, #03-05
WOODLANDS POINT, SINGAPORE 738931
Tel.+65-6362-7980 Fax.+65-6362-7980

THAILAND

SIAM NIKKEN Co., LTD.
127 Moo5 Gauwungsai-Bangturie Road Tambon Tanokkard
Ampher Muangnakhonpathom Nakhonpathom 73000 Thailand
Tel.+66(02)178-0503 Fax.+66(02)178-0504

<http://www.nikken-kosakusho.co.jp>
e-mail : export@nikken-kosakusho.co.jp

■Please give your order to the following agent.

D.LF.3

●Specifications are subject to change without notice.



FEATURES

RAC BALANCE CUT BORING HEAD	7
ZMAC ADVANCED BORING HEAD	8
DJ BORING HEAD	9
eMAC BORING HEAD	10

DIMENSIONS

BORING SYSTEM	3
RAC BALANCE CUT BORING ARBOR	RAC-E 11
	RAC 13
	RAC-A 15
	RAC-K 17
	RAC 19
RAC BORING HEAD	19
CARTRIDGE for RAC BORING HEAD	20
RAC BALANCE CUT BORING ARBOR for LARGE DIA	RAC 21
RAC BALANCE CUT MODULAR TYPE ARBOR & PLATE for LARGE DIA	RAK, RPC 22
ACCESSORIES for RAC BALANCE CUT BORING BAR	RCC 22
ZMAC ADVANCED BORING BAR	ZMAC-V 23
	ZMAC-VR 25
ZMAC ADVANCED BORING HEAD	ZMAC-V 27
ZMAC α ADVANCED BORING HEAD	ZMAC α -V 28
ZMAC ADVANCED (ISO) BORING HEAD	ZMAC-V-I 29
ZMAC α ADVANCED (ISO) BORING HEAD	ZMAC α -V-I 29
ZMAC ADVANCED UNIT (ISO) PARTS LIST	30
ZMAC ADVANCED BORING BAR for LARGE DIA	BAC-V 31
BCB MICRO CUT BORING BAR for LARGE DIA	BCB 32
ACCESSORIES for BORING BAR for LARGE DIA	BAC-V, BCB 33
SPECIAL DESIGNED BORING ARBOR	34
DJ BORING BAR	DJ 35
DJ BORING HEAD	DJ 35
BORING BIT for DJ	J 36
BT Shank BASE HOLDER for MODULAR type	Q 37
SPACER for MODULAR type	SP 38
MAJOR DREAM BASE HOLDER for MODULAR type	MDQ 39
Straight Shank BASE HOLDER	K-Q 39
BCB MICRO CUT BORING HEAD	BCB 40
Straight Shank RAC BALANCE CUT BORING BAR	K-RAC 41
Straight Shank ZMAC ADVANCED BORING BAR	K-ZMAC-V 41
Straight Shank DEEP HOLE ZMAC ADVANCED BORING BAR	S-ZMACX-V 42
Straight Shank DJ BORING BAR	K-DJ 43
MULTI STAGE BORING BAR	43
BORING BAR for SQUARE & CYLINDRICAL BORING TOOL	BSA, BSB, BOA 44

BT

3LOCK SYSTEM	MBT 45
---------------------	--------

MBT

BT DOUBLE FACE CONTACT SPINLE	NBT 46
2LOCK SYSTEM	NBT 46
MBT ZMAC ADVANCED BORING BAR	ZMAC-V 47
MBT RAC BALANCE CUT BORING BAR	RAC 48
MBT MODULAR type BORING BASE HOLDER	Q 49
MBT DJ BORING BAR	DJ 49
MBT ZMAC ADVANCED BORING ARBOR for LARGE DIA	BAC-V 50
MBT RAC BALANCE CUT BORING ARBOR for LARGE DIA	RAC 50

NBT

NBT ZMAC ADVANCED BORING BAR	ZMAC-V 51
NBT RAC BALANCE CUT BORING BAR	RAC 52
NBT MAJOR DREAM BASE HOLDER for MODULAR type	MDQ 52
NBT BASE HOLDER for MODULAR type	Q 53
NBT DJ BORING BAR	DJ 53
NBT ZMAC ADVANCED BORING ARBOR for LARGE DIA	BAC-V 54
NBT RAC BALANCE CUT BORING ARBOR for LARGE DIA	RAC 54

NC5

NC5 TOOLING SYSTEM	NC5 55
NC5 ZMAC ADVANCED BORING BAR	ZMAC-V 57
NC5 RAC BALANCE CUT BORING BAR	RAC 58
NC5 ZMAC ADVANCED BORING ARBOR for LARGE DIA	BAC-V 59
NC5 RAC BALANCE CUT BORING ARBOR for LARGE DIA	RAC 59
NC5 BASE HOLDER for MODULAR type	Q 60
NC5 TAPER GAUGE	SGT 61
NC5 TEST BAR	TB 61

HSK

HSK TOOLING SYSTEM	HSK 62
HSK RAC BALANCE CUT BORING BAR	RAC-E 63
	RAC 65
	RAC-A 67
	RAC-K 69
	RAC 71
HSK RAC BALANCE CUT BORING ARBOR for LARGE DIA	RAC 71
HSK RAC BALANCE CUT PLATE for LARGE DIA	RAK-RPC 72
HSK ZMAC ADVANCED BORING BAR	ZMAC-V 73
	ZMAC-VR 75
HSK ZMAC ADVANCED BORING ARBOR for LARGE DIA	BAC-V 77
HSK BCB MICRO CUT BORING BAR for LARGE DIA	BCB 78
HSK BASE HOLDER for MODULAR type	Q 79
HSK DJ BORING BAR	DJ 80
HSK MAJOR DREAM BASE HOLDER for MODULAR type	MDQ 80

POLYGONAL TAPER C6 BASE HOLDER for MODULAR type	Q 81
--	------

PARTS LIST

RAC BALANCE CUT BORING UNIT PARTS LIST	82
ZMAC ADVANCED BORING UNIT PARTS LIST	83
BCB MICRO-CUT BORING UNIT PARTS LIST	84
RAC BALANCE CUT BORING ARBOR CUTTING DATA	85
ZMAC ADVANCED BORING SYSTEM CUTTING DATA	86
DJ BORING ARBOR CUTTING DATA	87
INSERT TIP	88

eMAC

eMAC BORING HEAD	eMAC 91
eMAC-W BORING HEAD	eMAC-W 92
BASE HOLDER for eMAC BORING HEAD	Q26 93
BASE HOLDER for eMAC-W BORING HEAD	Q42 94
BORING BIT & CARTRIDGE for eMAC BORING SYSTEM	95
eMAC BORING SYSTEM CUTTING DATA	96
eMAC & eMAC-W BORING SET PARTS LIST	97



BORING SYSTEM

ROUGH BORING

RAC-E (Steel, Stainless Steel, Cast Iron)

BT  P.11

MBT  P.48

NBT  P.52

NC5  P.58

HSK  P.63

CC
Positive type
φ25~φ130



RAC (Heavy Duty Boring)

BT  P.13

MBT  P.48

NBT  P.52

NC5  P.58

HSK  P.65

CN
Negative type
φ43~φ130



RAC-A (Aluminium)

BT  P.15

MBT  P.48

NBT  P.52

NC5  P.58

HSK  P.67

φ25~φ130



ROUGH BORING

RAC-K (Through Hole / Multi Sheets)

BT  P.17

MBT  P.48

NBT  P.52

NC5  P.58

HSK  P.69

φ25~φ130



RAC (For Large Dia)

BT  P.21

MBT  P.50

NBT  P.54

NC5  P.59

HSK  P.71

φ130~φ580



SEMI-FINISH BORING

ZMAC-VR

BT  P.25

MBT  P.47

NBT  P.51

NC5  P.57

HSK  P.75

φ32~φ180



BCB (For Large Dia)

BT  P.32

HSK  P.78

φ130~φ595



FINISH BORING

DJ

BT  P.35

MBT  P.49

NBT  P.53

HSK  P.80

φ3~φ50



FINISH BORING

ZMAC-V

BT  P.23

MBT  P.47

NBT  P.51

NC5  P.57

HSK  P.73

φ16~φ180



ZMAC α-V

BT  P.24

MBT  P.47

NBT  P.51

NC5  P.57

HSK  P.74

φ25~φ180



BAC-V (For Large Dia)

BT  P.31

MBT  P.50

NBT  P.54

NC5  P.59

HSK  P.77

φ130~φ595



MODULAR SYSTEM

Base Holder Q  P.37



Spacer SP  P.38



COOLANT THROUGH

RAC-C



High Pressure Coolant Through Tool

STRAIGHT SHANK

K-RAC K-ZMAC-V  P.41 S-BCBX S-ZMACX-V  P.42
K-DJ  P.43



$\phi 25 \sim \phi 100$ $\phi 16 \sim \phi 70$ $\phi 3 \sim \phi 50$



$\phi 12.7 \sim \phi 55$

ZMAC-V



High Pressure Coolant Through Tool

SPECIAL BORING BAR

Multi-Stage, External  P.34, P. 43



Boring, Overturning  P.34, P. 43



DJ



High Pressure Coolant Through Tool

FINISH BORING

eMAC  P.91



$\phi 6 \sim \phi 110$

eMAC-W  P.92



$\phi 6 \sim \phi 200$

RAC / BAC-VC for LARGE DIA.



High Pressure Coolant Through Tool

MODULAR ZMAC ADVANCED BORING BAR

BASE-HOLDER

Q26 type base holder can be used for various combinations.
Ideal for low volume production on manual machine with wide variety of boring sizes.
We recommend that you also use the Q42 base holder on #50 M/C. P.37

Spacer & Head

The extensive range of heads & spacers allow the correct selection to suit your boring applications.

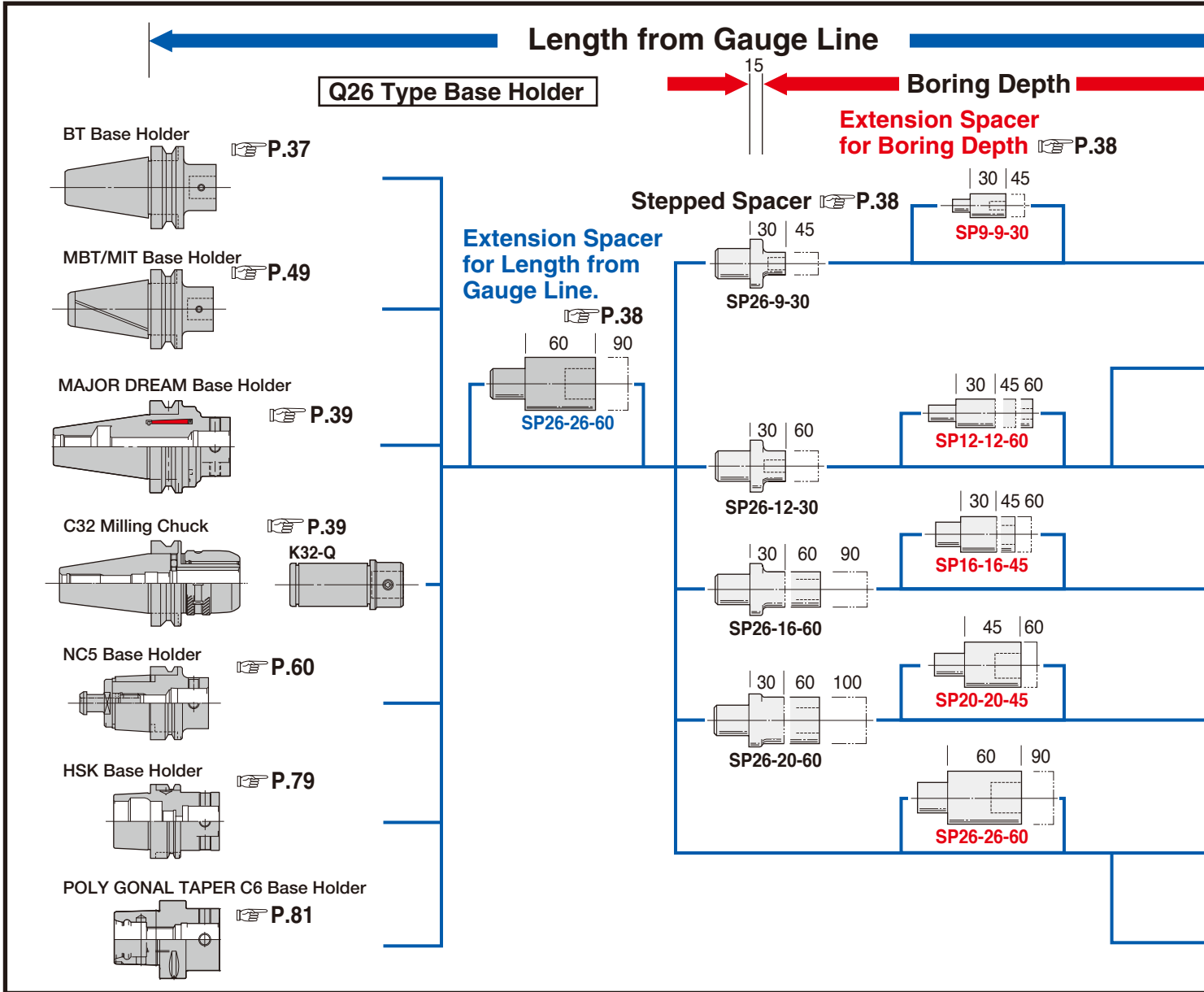

BORING ARBOR FOR LARGE DIA

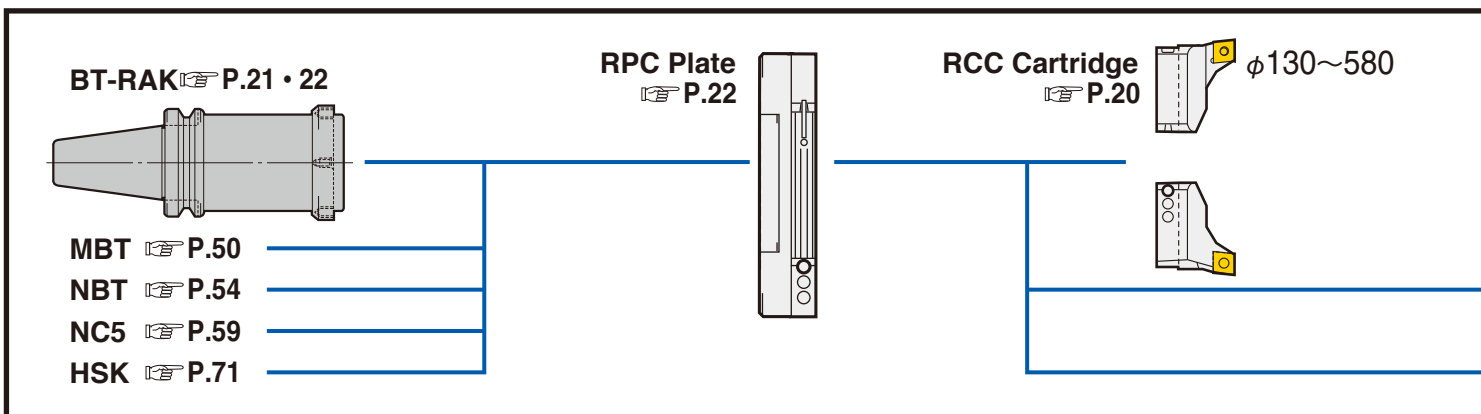

Method of Selection for Modular ZMAC-V Boring Arbors
 Firstly, select a head, spacer and stepped spacer from boring diameter and depth.
 Then select base holder and SP26 extension spacer by the length from gauge line.

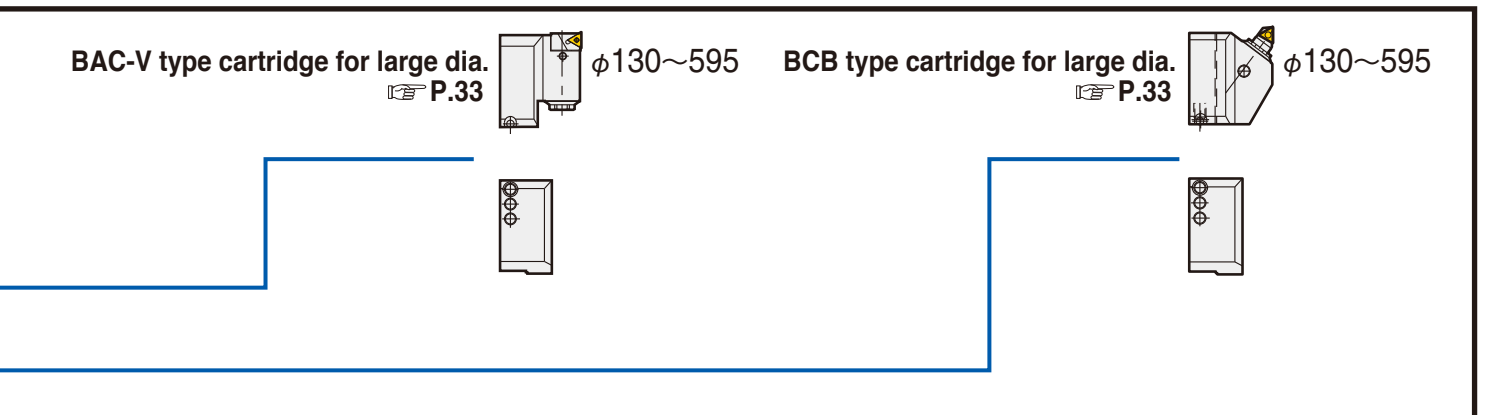
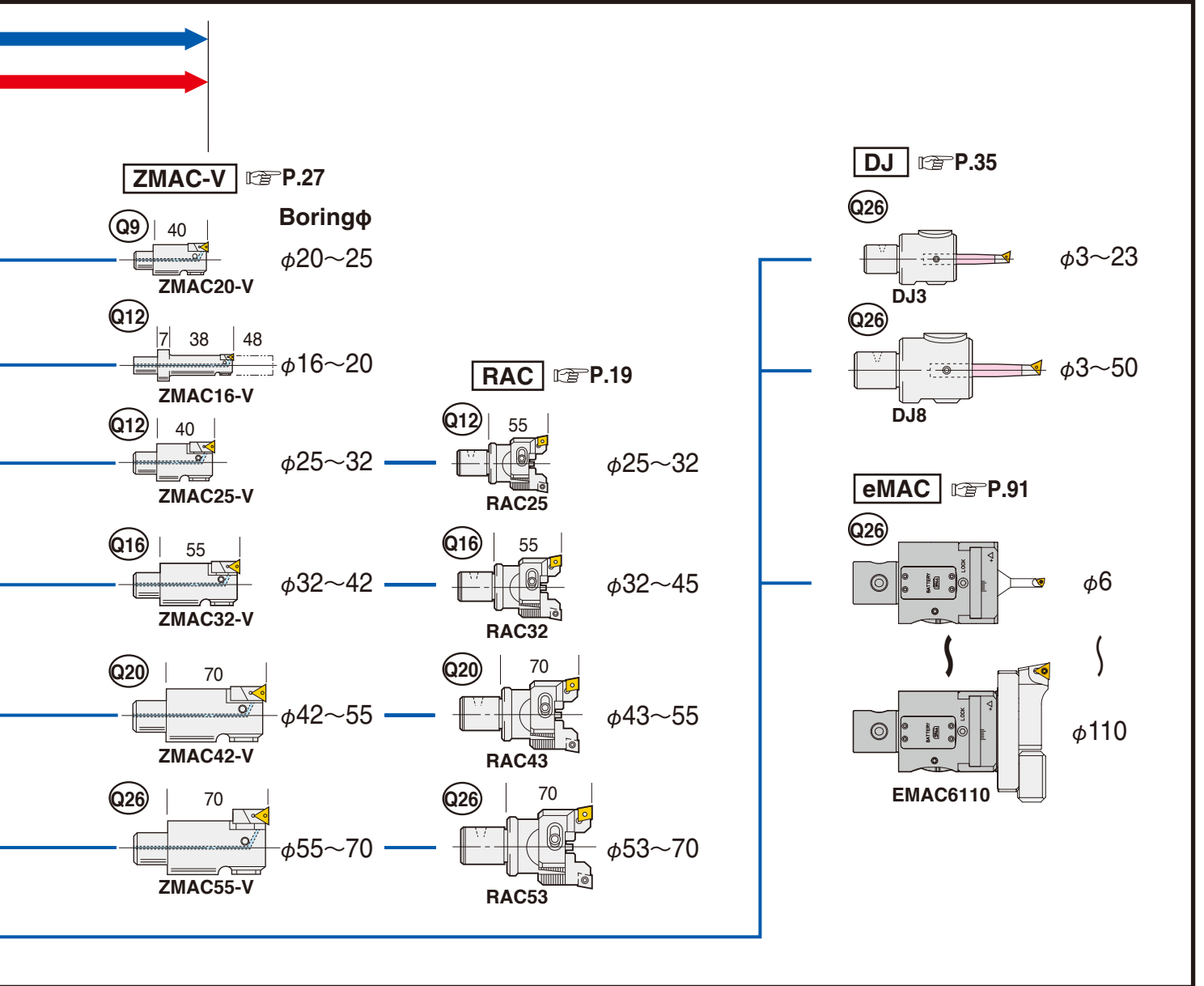

φ25~580 Scram Type Cartridge Power & Smooth Boring



Double Cutting Capability

From φ25~580mm, all Balance Cut Boring Bars execute boring in 2 Carbide Inserts. One side cutting will not occur, and vibration is absorbed each other. The faster the feed rate (0.2~0.4mm/rev.), the better swarf ejection. Ideal for Rough and Medium Boring.

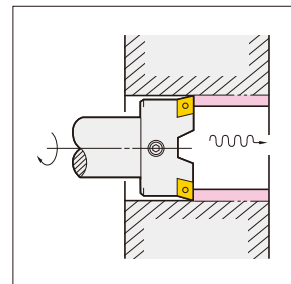

2 Stepped Balance Cut

Approx. double removal of standard cutting condition is possible by **-0.3mm Cartridge**.

Stepped Boring

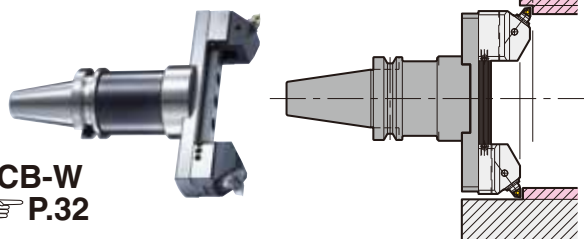

BCB-W
P.32

Various Cartridges & Inserts

Good Chip Ejection ensures no trouble Heavy Boring. Standard carbide insert is suitable both for Steel and Cast Iron. Besides, optional cartridges for steel, for Aluminium, through hole or multi-sheets are available.

RAC-E

RAC-A

RAC-K



Power of Scram Type Cartridge

Cutting force is supported by the shoulders of both cartridges. This is the secret of heavy and powerful boring even at the intermittent bore.

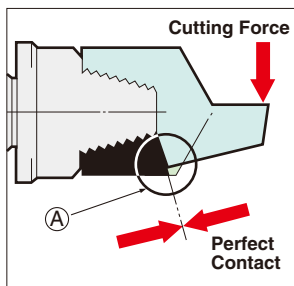

Precision Ground Serration

High Precision Serration is the base of high accurate performance of BALANCE CUT Boring Bar.

- Even strong cutting force is accepted by High Precision Serration, resulting in smooth boring without micro vibration.
- All slides are finished by precision grinding. Even micro adjustment can be done smoothly as you desire.
- The addition of manufacturing processes realizes an even higher precision.

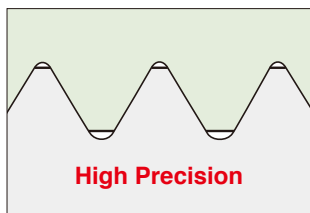

Precision Ground = Basic Serration

High Pressure Coolant Through Tool



- Cutting Speed 150m/min
- Feed Rate 0.4~0.6mm/rev
- Stock Removal 6~10mm(on dia.)
- Boring Dia φ60mm
- Material SNCM420 (Ni, Cr, Mo Alloy Steel)

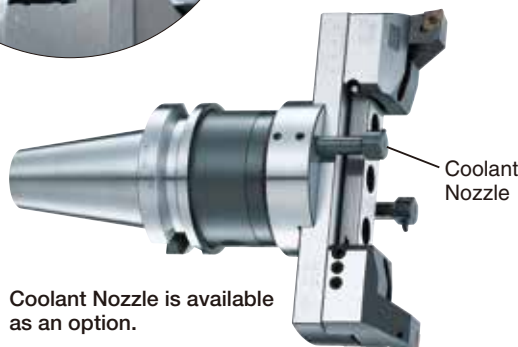

Coolant Nozzle is available as an option.

φ16~180 The World Leading Boring Head



Various types of Insert Tips

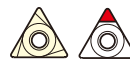
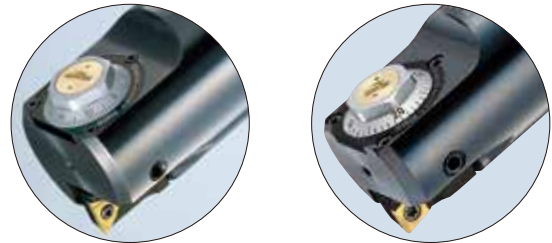

Steel, cast iron, and stainless steel can be machined by the same coated insert tip. Specifications that support insert tips which are widely circulating on the market are also available. ➔ P.30 ZMAC-V-1

Application

NIKKEN makes use of its abundant experiences and results to provide special boring bars, which are suited for various work shapes as part of the solutions to streamline production.



High rigidity Double-contact support

Innovative new feature of Double-Contact Support

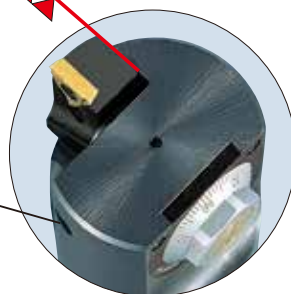

New Locking screw closer to Cutting Edge

High-precision / Easy micro-adjustment / High durability / High rigidity

New lock flanges reduce dial torque and increase visibility. ZMAC25-V and larger also have a sub scale for easier and more accurate diameter adjustments.

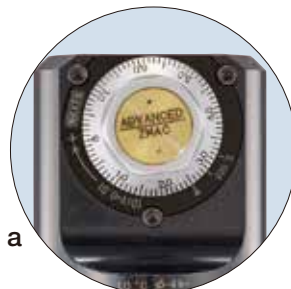

Coolant Specifications for All Sizes

All sizes from φ16 to φ180 have coolant holes positioned so that the coolant is applied directly to the cutting edge. ZMAC70-V and larger use a variable nozzle system.



High Speed Boring 12,000nin⁻¹, Deep Hole Boring

Balance Weight

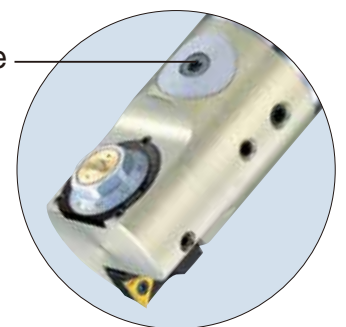

ZMACα-V

Special Hardened Light Alloy Metal Head with Balancing for Anti-Vibration.

$\phi 3 \sim 50$ Developed with all of NIKKEN Knowhows-Best Help of Fine Boring



Photo shows new DJ8 series.

Easy to Set Micron Accuracy

Easy operation with big dial graduations together with a wide adjusting range for fine boring of dia.3~50mm.

Dial Graduation
 1 Graduation:dia.0.01mm
 Vernier reading:dia. 0.005mm
 Smooth and High Precision Boring is ensured.

Micron accuracy can be obtained easily

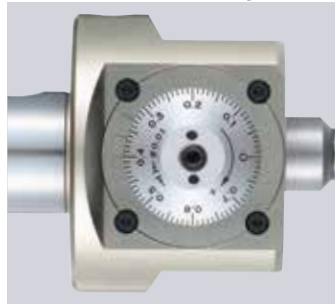

No Vibration and Least Wearing of Carbide Insert.

4 pcs of DJ Boring Bits are provided as standard accessories. Even 1mm stock removal on diameter can be done with maintaining fine surface finish without vibration.



$\phi 3 \sim 8$ mm

New Bit Series for DJ8  **P.84**

Special Carbide Indexable Insert for $\phi 5$ mm Boring

Now Special Carbide Indexable Inserts for $\phi 5 \sim 15$ mm are available for DJ Bit. No more regrinding and the **shank is solid Carbide**. Fine boring of $\phi 5$ mm from 4.5mm drilled hole can be done without vibration and without bending. Fine boring of Safety and Sureness by DJ Boring Head.



High Pressure Coolant Through Type



- Cutting Speed..... 100m/min.
- Feed 0.05mm/rev
- Stock Removal 0.5mm(on Dia.)
- Boring dia..... $\phi 30$ mm
- Material..... SKD11

Oil Hole Bit for DJ3,DJ8  **P.36**

$\phi 6 \sim 200$ Easy-to-See Digital Displays / Supports Small to Large Diameters



Digital Displays for Easy Diameter Adjustments

A digital display enables easily made adjustments, even in increments as small as 2 microns in diameter.

Various settings can be changed by operating the single Select Button.

Sizes are switchable between metric and imperial units.

The minimum set value for imperial size display is 0.0001".



Select button

Combination Systems Support a Wide Machining Range

A combination system realizes a wide machining range as it enables the mounting of boring cartridges that use both a cylindrical boring bit and serration.

eMAC : $\phi 6 \sim 110$

eMAC-W: $\phi 6 \sim 200$

※Set products capable of boring in the range of $\phi 6$ to $\phi 110$ are also available. ➔ P.97



Coolant through Tool Capability Provided as a Standard

Coolant through tool capability that supports pressures up to 4 MPa is provided as a standard.

Coolant is discharged from the cutting edge of cylindrical boring bits, or from a coolant nozzle located near the cutting edge of cartridges.

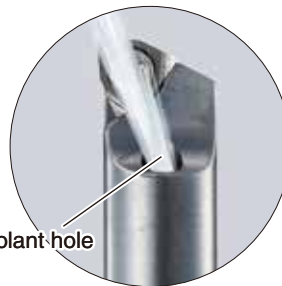

Coolant hole



Coolant nozzle

Waterproof Rating: IP67

Waterproof Rating: IP67
Waterproof specifications at an IP67 rating help keep the internal electronics safe, and the cover for the SR44 batteries (2 pcs) has seal specifications that enable repeated removal and attachment.



Battery cover

BALANCE-CUT BORING ARBOR (RAC-E)



Rough Boring — For Steel, Stainless Steel and Cast Iron
CC Insert (Positive type)



RAC-E

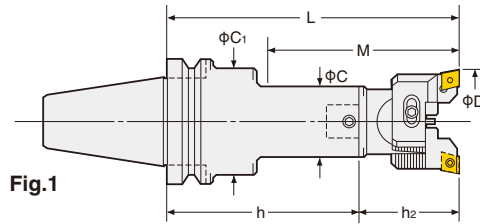

Fig.1

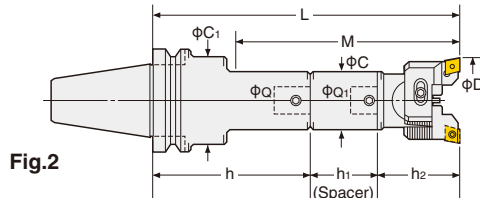
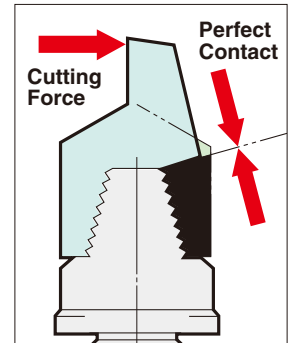

Fig.2

Power of Shoulder Support



TAPER	Code No.	Boring Range D	Boring Depth M	Cupling Dia Q	C	C ₁	Shank Code No.	Spacer Code No.	P.12		Weight (kg)	Fig
									Head Code No.	Tip No.		
No.40	BT40-RAC 25-135E	25~32	67	12	24	35	BT40-Q12- 80	—	12-RAC 25- 55E	CC07-C	2.0	1
	(IT40) -165E		105				-Q12-110				2.1	
	-180E		112				-Q12- 80				SP12-12-45	
	-RAC 32-150E	32~45	77	16	31	42	-Q16- 95	—	16-RAC 32- 55E	CC08-C	2.4	1
	-180E		110				-Q16-125				2.6	
	-195E		122				-Q16- 95				SP16-16-45	
	-RAC 43-150E	43~55	97	20	40	50	-Q20- 80	—	20-RAC 43- 70E	—	2.7	1
	-180E		130				-Q20-110				2.9	
	-210E		157				-Q20- 80				SP20-20-60	
	-RAC 53-165E	53~70	135	26	50	50	-Q26- 95	—	26-RAC 53- 70E	CC12-C	2.5	1
	-210E		180				-Q26-140				3.3	
	-225E		195				-Q26- 95				SP26-26-60	
	-RAC 70-180E	70~100	180	34	64	64	-Q34- 95	—	34-RAC 70- 85E	—	4.8	1
	-195E		195				-Q34-110				5.2	
	-240E		240				-Q34- 95				SP34-34-60	
	-RAC100-195E	100~130	195	42	83	62	-Q42- 95	—	42-RAC100-100E	—	6.8	1

★“C” grade (Coated) inserts are supplied as standard with the head. P.12 Please refer P.85 for cutting condition.

★Please refer P.37 for base holder, P.38 for spacer and P.19 for head.

★For centre through tool coolant type, please add “-C” at the end of Code No. e.g. BT40-RAC53-165E-C

★When L length is required longer than standard, please specify the boring depth M.

★BT30 is a modular type. Please refer to P.37 for the base holder.

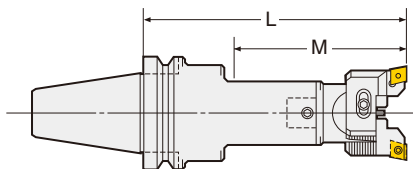

High Pressure Coolant Through Tool

BALANCE-CUT BORING ARBOR (RAC-E)

NIKKEN

Balance cut boring bar executes boring in 2 cartridge inserts absorbing the vibration each other. The faster the feed rate, the better swarf ejection. This is ideal for rough and medium boring.

Double Cutting Capability

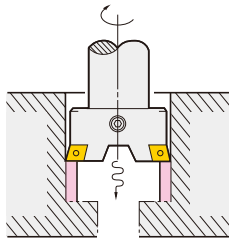

Please use RAC-K for through hole boring.

☞ P.17, P.18



Example of 2 Stepped Balance Cut

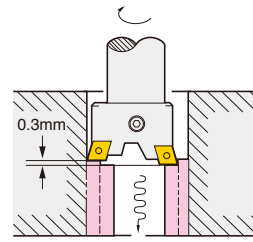

Approx. double removal of below cutting condition is possible by -0.3 Cartridge.

☞ P.20

TAPER	Code No.	Boring Range D	Boring Depth M	Cupling Dia Q	C	C ₁	Shank Code No.	Spacer Code No.	P.12		Weight (kg)	Fig	
									Head Code No.	Tip No.			
No.50	BT50-RAC 25-150E	25~ 32	67	12	24	44	BT50-Q12- 95	—	12-RAC 25- 55E	CC07-C	4.7	1	
	(IT50) -180E		105				-Q12-125				4.9		
	-195E		112				-Q12- 95				4.8		2
	-RAC 32-180E	32~ 45	77	16	31	50	-Q16-125N	—	16-RAC 32- 55E	CC08-C	5.4	1	
	-210E		110				-Q16-155				5.6		
	-225E		122				-Q16-125N				5.6		2
	-RAC 43-180E	43~ 55	97	20	40	60	-Q20-110	—	20-RAC 43- 70E	—	5.7	1	
	-195E		130				-Q20-125				5.8		
	-225E		142				-Q20-110				6.1		2
	-240E		157				SP20-20-45 SP20-20-60				6.2		
	-RAC 53-210E	53~ 70	117	26	50	65	-Q26-140	—	26-RAC 53- 70E	—	6.9	1	
	-240E		182				-Q26-170N				7.0		
	-270E		177				-Q26-140				7.6		2
	-RAC 70-255E		205				-Q34-170				9.5		
	-285E	235	-Q34-200	9.9	1								
	-315E	265	-Q34-170	10.9		2							
	-RAC100-225E	100~130	225	42	83		83	-Q42-125	—	42-RAC100-100E	—	12.5	1
	-290E		290			-Q42-190		15.2					
	-325E		325			-Q42-225A		16.5				2	

★“C” grade (Coated) inserts are supplied as standard with the head. ☞ P.12 Please refer ☞ P.85 for cutting condition.

★Please refer ☞ P.37 for base holder, ☞ P.38 for spacer and ☞ P.19 for head.

★For centre through tool coolant type, please add “-C” at the end of Code No. e.g. BT50-RAC53-210E-C

★BT50-RAC100-375E, 425E and 475E are also available.

Insert tip for RAC-E

● : best ○ : good

Material	Steel	●			
	Stainless Steel	●			
Material	Cast Iron	○	●		
	Aluminium				
	Coated Carbide M	Coated Carbide K			
	Grade	C			
	Material	AC630M	AC410K		
Applicable Arbor	Dimension	Code No.	Nose R	AC630M	AC410K
RAC025E		CC07-○4	0.4	●	●
		CC07-○8	0.8	●	●
RAC25E(CC08), RAC32E		CC08-○4	0.4	●	●
		CC08-○8	0.8	●	●
RAC43E - RAC530E		CC12-○4	0.4	●	●
		CC12-○8	0.8	●	●

Please add the grade indication into ○, and add the insert tip material indication at the end of the Code No. e.g. CC12-C8 (AC630M)

★Minimum order quantity : 10pcs.

B1

BALANCE-CUT BORING ARBOR (RAC)



Rough Boring— For Heavy Duty Boring of Iron and Cast Iron
CN Insert (Negative type)



Heavy Duty Boring

RAC

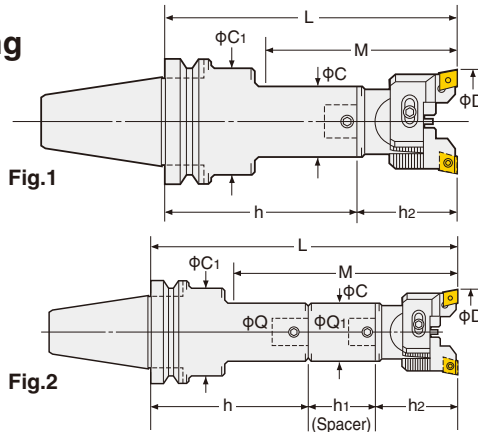

Power of Shoulder Support

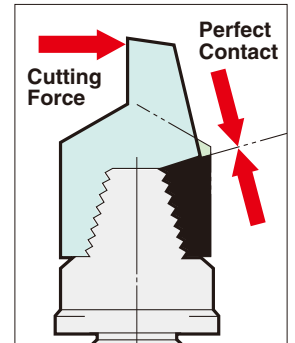

TAPER	Code No.	Boring Range D	Boring Depth M	Cupling Dia Q	C	C ₁	Shank Code No.	Spacer Code No.	P.14		Weight (kg)	Fig
									Head Code No.	Tip No.		
No.40	BT40-RAC 43-150	43~55	97	20	40	50	BT40-Q20- 80	—	20-RAC 43- 70	CN08-C	2.7	1
	(IT40) -180		130				-Q20-110	—			2.9	
	-210		157				-Q20- 80	SP20-20-60			3.2	2
	-RAC 53-165	53~70	135	26	50	-Q26- 95	—	26-RAC 53- 70	CN08-C	2.5	1	
	-210		180			-Q26-140	—			3.3		
	-225		195			-Q26- 95	SP26-26-60			3.2	2	
	-RAC 70-180	70~100	180	34	64	-Q34- 95	—	34-RAC 70- 85	CN08-C	4.8	1	
	-195		195			-Q34-110	—			5.2		
	-240		240			-Q34- 95	SP34-34-60			6.2	2	
	-RAC100-195	100~130	195	42	83	62	-Q42- 95	—	42-RAC100-100	6.8	1	

- ★“C” grade (Coated) inserts are supplied as standard with the head. P.14 Please refer P.85 for cutting condition.
- ★Please refer P.37 for base holder, P.38 for spacer and P.19 for head.
- ★For centre through tool coolant type, please add “-C” at the end of Code No. e.g. BT40-RAC53-165-C
- ★When L length is required longer than standard, please specify the boring depth M.
- ★BT30 is a modular type. Please refer to P.37 for the base holder.

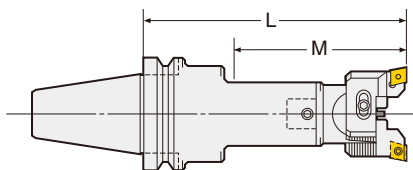

High Pressure Coolant Through Tool

BALANCE-CUT BORING ARBOR (RAC)



Balance cut boring bar executes boring in 2 cartridge inserts absorbing the vibration each other. The faster the feed rate, the better swarf ejection. This is ideal for rough and medium boring.

Double Cutting Capability

Please use RAC-K for through hole boring. P.17, P.18

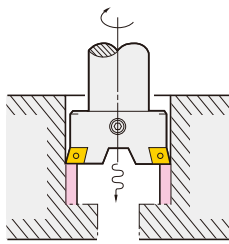

Example of 2 Stepped Balance Cut

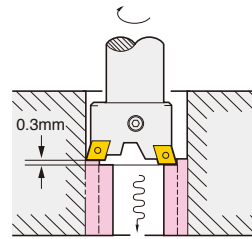

Approx. double removal of below cutting condition is possible by **-0.3 Cartridge**. P.20

TAPER	Code No.	Boring Range D	Boring Depth M	Coupling Dia Q	C	C ₁	Shank Code No.	Spacer Code No.	P.14		Weight (kg)	Fig
									Head Code No.	Tip No.		
No.50	BT50-RAC 43-180	43~ 55	97	20	40	60	BT50-Q20-110	—	20-RAC 43- 70	CN08-C	5.7	1
	(IT50) -195		130				-Q20-125				5.8	
	-225		142				-Q20-110				6.1	2
	-240		157				SP20-20-45				6.2	
	-RAC 53-210	53~ 70	117	26	50	65	-Q26-140	—	26-RAC 53- 70	CN08-C	6.9	1
	-240		182				-Q26-170N				7.0	
	-270		177				-Q26-140				7.6	2
	-RAC 70-255	70~100	205	34	64	80	-Q34-170	—	34-RAC 70- 85	CN08-C	9.5	1
	-285		235				-Q34-200				9.9	
	-315		265				-Q34-170				10.9	2
	-RAC100-225	100~130	225	42	83	83	-Q42-125	—	42-RAC100-100	CN08-C	12.5	1
	-290		290				-Q42-190				15.2	
	-325		325				-Q42-225A				16.5	2

★“C” grade (Coated) inserts are supplied as standard with the head. P.14 Please refer P.85 for cutting condition.

★Please refer P.37 for base holder, P.38 for spacer and P.19 for head.

★For centre through tool coolant type, please add “-C” at the end of Code No. e.g. BT50-RAC53-210-C

★BT50-RAC100-375, 425 and 475 are also available.

★Code No. of RAC25 and RAC32 with CC inserts are changed to RAC25E and RAC32E. Please refer P.11, P.12

Insert tip for RAC for Heavy Duty Boring

Material	Steel	●		
	Stainless Steel	●		
Cast Iron	●			
Aluminium	●			
	Coated Carbide M			
	Grade	C		
	Material	AC630M		
Applicable Arbor	Dimension	Code No.	Nose R	
RAC43 - RAC530	 (CNMM120408)	CN08-○8	0.8	●

Please add the grade indication into ○, and add the insert tip material indication at the end off the Code No. e.g. CN08-C8 (AC630M)

★Minimum order quantity : 10pcs.

★When CN08 insert (CN○○1204○○) in the market is used, please use the eccentric bolt type cartridge (S.RCC-○○Q) P.82. Nikken CN08-○8 insert can be used on the eccentric bolt type cartridge.

BALANCE-CUT BORING ARBOR (RAC-A)

NIKKEN

Rough Boring—For Aluminium



RAC-A

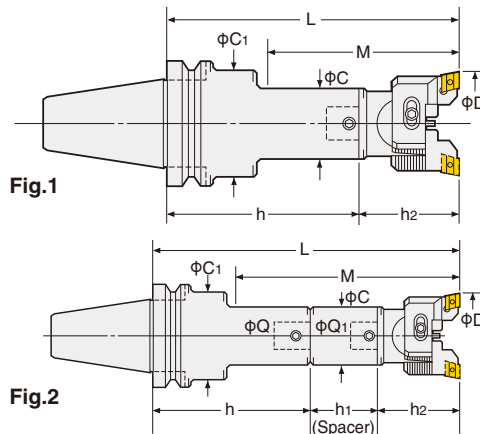

Power of Shoulder Support

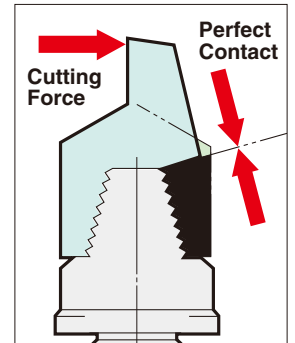

TAPER	Code No.	Boring Range D	Boring Depth M	Cupling Dia Q	C	C ₁	Shank Code No.	Spacer Code No.	P.16		Weight (kg)	Fig
									Head Code No.	Tip No.		
No.40	BT40-RAC 25-135A	25~32	67	12	24	35	BT40-Q12- 80	—	12-RAC 25- 55A	AEG12	2.0	1
	(IT40) -165A		105				-Q12-110	—			2.1	
	-180A		112				-Q12- 80	SP12-12-45			2.1	
	-RAC 32-150A	32~45	77	16	31	42	-Q16- 95	—	16-RAC 32- 55A	AEG12	2.4	1
	-180A		110				-Q16-125	—			2.6	
	-195A		122				-Q16- 95	SP16-16-45			2.6	
	-RAC 43-150A	43~55	97	20	40	50	-Q20- 80	—	20-RAC 43- 70A	AEG16	2.7	1
	-180A		130				-Q20-110	—			2.9	
	-210A		157				-Q20- 80	SP20-20-60			3.2	
	-RAC 53-165A	53~70	135	26	50	64	-Q26- 95	—	26-RAC 53- 70A	AEG16	2.5	1
	-210A		180				-Q26-140	—			3.3	
	-225A		195				-Q26- 95	SP26-26-60			3.2	
	-RAC 70-180A	70~100	180	34	64	64	-Q34- 95	—	34-RAC 70- 85A	AEG16	4.8	1
	-195A		195				-Q34-110	—			5.2	
	-240A		240				-Q34- 95	SP34-34-60			6.2	
	-RAC100-195A	100~130	195	42	83	62	-Q42- 95	—	42-RAC100-100A	—	6.8	1

- ★“F” grade inserts are supplied as standard with the head. P.16 Please refer P.85 for cutting condition.
- ★Please refer P.37 for base holder, P.38 for spacer and P.19 for head.
- ★For centre through tool coolant type, please add “-C” at the end of Code No. e.g. BT40-RAC53-165A-C
- ★When L length is required longer than standard, please specify the boring depth M.
- ★BT30 is a modular type. Please refer to P.37 for the base holder.

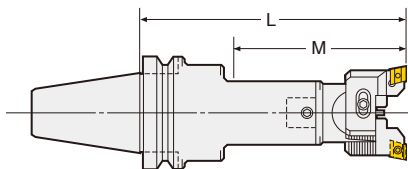

High Pressure Coolant Through Tool

BALANCE-CUT BORING ARBOR (RAC-A)

NIKKEN

Balance cut boring bar executes boring in 2 cartridge inserts absorbing the vibration each other. The faster the feed rate, the better swarf ejection. This is Ideal for rough and medium boring.

Double Cutting Capability

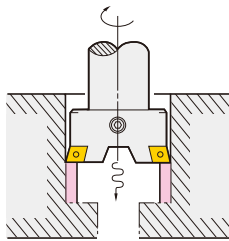

Example of 2 Stepped Balance Cut

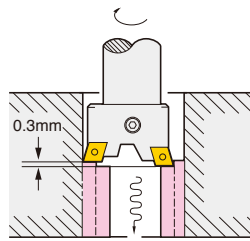

Approx. double removal of below cutting condition is possible by **-0.3 Cartridge**.
 ☞ P.20

TAPER	Code No.	Boring Range D	Boring Depth M	Coupling Dia Q	C	C ₁	Shank Code No.	Spacer Code No.	P.16		Weight (kg)	Fig
									Head Code No.	Tip No.		
No.50	BT50-RAC 25-150A	25~ 32	67	12	24	44	BT50-Q12- 95	—	12-RAC 25- 55A	AEG12	4.7	1
	(IT50) -180A		105				-Q12-125				4.9	
	-195A		112				-Q12- 95				4.8	
	-RAC 32-180A	32~ 45	77	16	31	50	-Q16-125N	—	16-RAC 32- 55A	AEG12	5.4	1
	-210A		110				-Q16-155				5.6	
	-225A		122				-Q16-125N				5.6	
	-RAC 43-180A	43~ 55	97	20	40	60	-Q20-110	—	20-RAC 43- 70A	AEG16	5.7	1
	-195A		130				-Q20-125				5.8	
	-225A		142				-Q20-110				6.1	
	-240A		157				SP20-20-45 SP20-20-60				6.2	
	-RAC 53-210A	53~ 70	117	26	50	65	-Q26-140	—	26-RAC 53- 70A	AEG16	6.9	1
	-240A		182				-Q26-170N				7.0	
	-270A		177				-Q26-140				7.6	
	-RAC 70-255A	70~100	205	34	64	80	-Q34-170	—	34-RAC 70- 85A	AEG16	9.5	1
	-285A		235				-Q34-200				9.9	
	-315A		265				-Q34-170				10.9	
	-RAC100-225A	100~130	225	42	83	83	-Q42-125	—	42-RAC100-100A	AEG16	12.5	1
	-290A		290				-Q42-190				15.2	
	-325A		325				-Q42-225A				16.5	

- ★“F” grade inserts are supplied as standard with the head. ☞ P.16 Please refer ☞ P.85 for cutting condition.
- ★Please refer ☞ P.37 for base holder, ☞ P.38 for spacer and ☞ P.19 for head.
- ★For centre through tool coolant type, please add “-C” at the end of Code No. e.g. BT50-RAC53-210A-C
- ★BT50-RAC100-375A, 425A and 475A are also available.

Insert tip for RAC-A

Material	Steel		Stainless Steel		Cast Iron		Aluminium	
	●	●	●	●	●	●	●	
Applicable Arbor	Dimension	Code No.	Nose R	Coated Carbide K				
				Grade	Material			
RAC25A, RAC32A		AEG12-○1	0.1	●	F			
		AEG12-○2	0.2	●	KW10			
		AEG12-○4	0.4	●	KW10			
RAC43A-RAC530A		AEG16-○1	0.1	●	F			
		AEG16-○2	0.2	●	KW10			
		AEG16-○4	0.4	●	KW10			

Please add the grade indication into ○, and add the insert tip material indication at the end off the Code No. e.g. AEG16-F2 (KW10)

★Minimum order quantity : 10pcs.

BT

BALANCE-CUT BORING ARBOR (RAC-K)



Rough Boring—For Through Hole and Multi Sheets



RAC-K

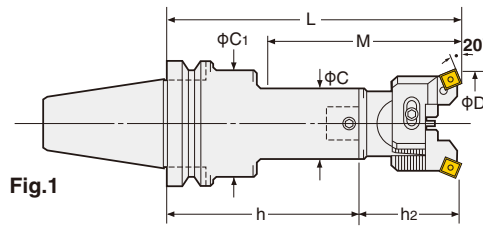

Fig.1

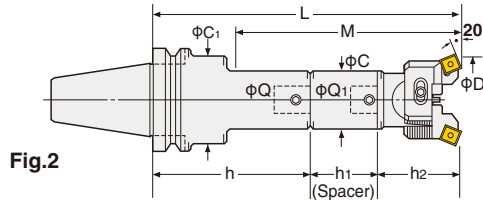
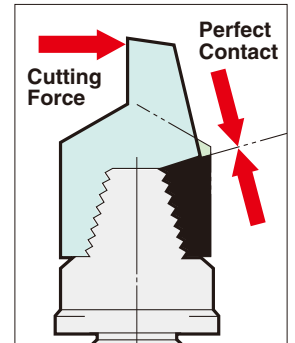

Fig.2

Power of Shoulder Support



TAPER	Code No.	Boring Range D	Boring Depth M	Cupling Dia Q	C	C ₁	Shank Code No.	Spacer Code No.	P.18		Weight (kg)	Fig
									Head Code No.	Tip No.		
No.40	BT40-RAC 25-135K	25~32	67	12	24	35	BT40-Q12- 80	—	12-RAC 25- 55K	SC09	2.0	1
	(IT40) -165K		105				-Q12-110				2.1	
	-180K		112				-Q12- 80				SP12-12-45	
	-RAC 32-150K	32~45	77	16	31	42	-Q16- 95	—	16-RAC 32- 55K	SC12	2.4	1
	-180K		110				-Q16-125				2.6	
	-195K		122				-Q16- 95				SP16-16-45	
	-RAC 43-150K	43~55	97	20	40	50	-Q20- 80	—	20-RAC 43- 70K	SC12	2.7	1
	-180K		130				-Q20-110				2.9	
	-210K		157				-Q20- 80				SP20-20-60	
	-RAC 53-165K	53~70	135	26	50	64	-Q26- 95	—	26-RAC 53- 70K	SC12	2.5	1
	-210K		180				-Q26-140				3.3	
	-225K		195				-Q26- 95				SP26-26-60	
	-RAC 70-180K	70~100	180	34	64	64	-Q34- 95	—	34-RAC 70- 85K	SC12	4.8	1
	-195K		195				-Q34-110				5.2	
	-240K		240				-Q34- 95				SP34-34-60	
	-RAC100-195K	100~130	195	42	83	62	-Q42- 95	—	42-RAC100-100K	SC12	6.8	1

★“C” grade (Coated) inserts are supplied as standard with the head. Please refer P.18 for cutting condition.

★Please refer P.37 for base holder, P.38 for spacer and P.19 for head.

★For centre through tool coolant type, please add “-C” at the end of Code No. e.g. BT40-RAC53-165K-C

★When L length is required longer than standard, please specify the boring depth M.

★BT30 is a modular type. Please refer to P.37 for the base holder.

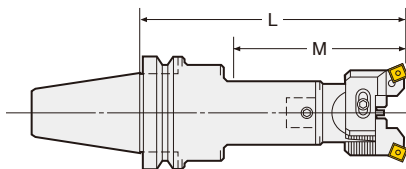

High Pressure Coolant Through Tool

BALANCE-CUT BORING ARBOR (RAC-K)

NIKKEN

Balance cut boring bar executes boring in 2 cartridge inserts absorbing the vibration each other. The faster the feed rate, the better swarf ejection. This is Ideal for rough and medium boring.

Double Cutting Capability

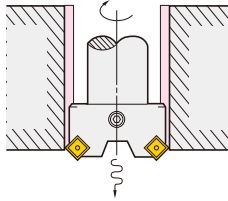

TAPER	Code No.	Boring Range D	Boring Depth M	Coupling Dia Q	C	C ₁	Shank Code No.	Spacer Code No.	P.18		Weight (kg)	Fig
									Head Code No.	Tip No.		
No.50	BT50-RAC 25-150K	25~ 32	67	12	24	44	BT50-Q12- 95	—	12-RAC 25- 55K	SC09	4.7	1
	(IT50) -180K		105				-Q12-125	—			4.9	
	-195K		112				-Q12- 95	SP12-12-45			4.8	2
	-RAC 32-180K	32~ 45	77	16	31	50	-Q16-125N	—	16-RAC 32- 55K	SC09	5.4	1
	-210K		110				-Q16-155	—			5.6	
	-225K		122				-Q16-125N	SP16-16-45			5.6	2
	-RAC 43-180K	43~ 55	97	20	40	60	-Q20-110	—	20-RAC 43- 70K	SC12	5.7	1
	-195K		130				-Q20-125	—			5.8	
	-225K		142				-Q20-110	SP20-20-45			6.1	2
	-240K		157				-Q20-110	SP20-20-60			6.2	
	-RAC 53-210K	53~ 70	117	26	50	65	-Q26-140	—	26-RAC 53- 70K	SC12	6.9	1
	-240K		182				-Q26-170N	—			7.0	
	-270K		177				-Q26-140	SP26-26-60			7.6	2
	-RAC 70-255K	70~100	205	34	64	80	-Q34-170	—	34-RAC 70- 85K	SC12	9.5	1
	-285K		235				-Q34-200	—			9.9	
	-315K		265				-Q34-170	SP34-34-60			10.9	2
	-RAC100-225K	100~130	225	42	83	83	-Q42-125	—	42-RAC100-100K	SC12	12.5	1
	-290K		290				-Q42-190	—			15.2	
	-325K		325				-Q42-225A	—			16.5	2

★“C” grade (Coated) inserts are supplied as standard with the head. P.18 Please refer P.85 for cutting condition.

★Please refer P.37 for base holder, P.38 for spacer and P.19 for head.

★For centre through tool coolant type, please add “-C” at the end of Code No. e.g. BT50-RAC53-210K-C

★BT50-RAC100-375K, 425K and 475K are also available.

Insert tip for RAC-K

● : best ○ : good

Material	Steel	●	○			
	Stainless Steel	●	○			
Material	Cast Iron	○	●			
	Aluminium	○	●			
Applicable Arbor	Dimension	Code No.	Nose R	Coated Carbide M	Coated Carbide K	
				Grade	C	
				Material	AC630M	AC410K
RAC25K, RAC32K		SC09-○4	0.4	●	●	
RAC43K-RAC100K		SC12-○8	0.8	●	●	

Please add the grade indication into ○, and add the insert tip material indication at the end off the Code No. e.g. SC12-C8 (AC630M)

★Minimum order quantity : 10pcs.

BT

MODULAR TYPE RAC BORING HEAD

NIKKEN

RAC-E Balance-Cut Boring Head

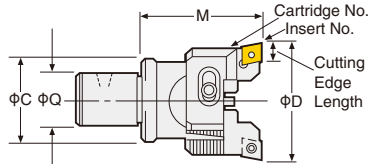

For Steel, Stainless Steel and Cast Iron
CC Insert (Positive type)

P.12

Head Code No.	Boring Range D	Boring Depth M	Coupling Dia Q	C	Cartridge No.	Insert No.	Cutting Edge Length	Weight (Kg)
12-RAC 25 - 55E	25 ~ 32	55	12	24	RCC-025E	CC07	8.0	0.4
16-RAC 32 - 55E	32 ~ 45		16	31	RCC- 32E	CC08	9.7	0.5
20-RAC 43 - 70E	43 ~ 55		20	40	RCC- 43E	CC12	12.9	0.7
26-RAC 53 - 70E	53 ~ 70	26	50	RCC- 53E	0.8			
26-RAC 70 - 70E	70 ~ 100			34	64			RCC- 70E
34-RAC 70 - 85E		85	64					1.5
42-RAC100 -100E	100 ~ 130	100	42	83	RCC-100E			2.9

★For centre through tool coolant type, please add “-C” at the end of Code No. e.g. 26-RAC53-70E-C

★Insert tips are supplied as an option. P.12 Please refer P.85 for cutting condition.

RAC Balance-Cut Boring Head

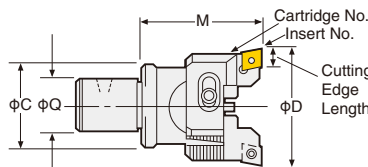

For Heavy Duty Boring of Iron and Cast Iron
CN Insert (Negative type)

P.14

Head Code No.	Boring Range D	Boring Depth M	Coupling Dia Q	C	Cartridge No.	Insert No.	Cutting Edge Length	Weight (Kg)
20-RAC 43 - 70	43 ~ 55	70	20	40	RCC- 43	CN08	12.9	0.7
26-RAC 53 - 70	53 ~ 70		26	50	RCC- 53			0.8
26-RAC 70 - 70	70 ~ 100				34			64
34-RAC 70 - 85		85	64	1.5				
42-RAC100 -100	100 ~ 130	100	42	83	RCC-100			2.9

★Insert tips are supplied as an option. P.14 Please refer P.85 for cutting condition.

★For centre through tool coolant type, please add “-C” at the end of Code No. e.g. 26-RAC53-70-C

RAC-A Balance-Cut Boring Head

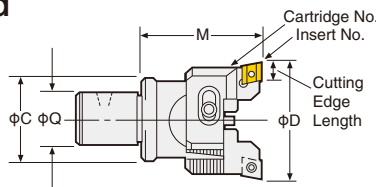

For Aluminum

P.16

Head Code No.	Boring Range D	Boring Depth M	Coupling Dia Q	C	Cartridge No.	Insert No.	Cutting Edge Length	Weight (Kg)	
12-RAC 25 - 55A	25 ~ 32	55	12	24	RAC- 25A	AEG12	9.5	0.4	
16-RAC 32 - 55A	32 ~ 45		16	31	RAC- 32A			0.5	
20-RAC 43 - 70A	43 ~ 55		20	40	RAC- 43A			AEG16	15.875
26-RAC 53 - 70A	53 ~ 70	26	50	RAC- 53A	0.8				
26-RAC 70 - 70A	70 ~ 100			34	64	RAC- 70A	1.0		
34-RAC 70 - 85A		85	64			1.5			
42-RAC100 -100A	100 ~ 130	100	42	83	RAC-100A			2.9	

★Insert tips are supplied as an option. P.16 Please refer P.85 for cutting condition.

★For centre through tool coolant type, please add “-C” at the end of Code No. e.g. 26-RAC53-70A-C

RAC-K Balance-Cut Boring Head

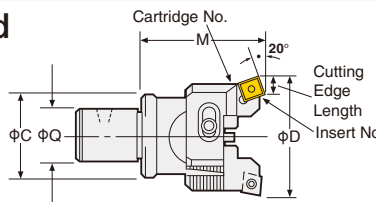

For Through Hole
and Multi Sheets

P.18

Head Code No.	Boring Range D	Boring Depth M	Coupling Dia Q	C	Cartridge No.	Insert No.	Cutting Edge Length	Weight (Kg)	
12-RAC 25 - 55K	25 ~ 32	55	12	24	RAC- 25K	SC09	7.4	0.4	
16-RAC 32 - 55K	32 ~ 45		16	31	RAC- 32K			0.5	
20-RAC 43 - 70K	43 ~ 55		20	40	RAC- 43K			SC12	11.9
26-RAC 53 - 70K	53 ~ 70	26	50	RAC- 53K	0.8				
26-RAC 70 - 70K	70 ~ 100			34	64	RAC- 70K	1.0		
34-RAC 70 - 85K		85	64			1.5			
42-RAC100 -100K	100 ~ 130	100	42	83	RAC-100K			2.9	

★Insert tips are supplied as an option. P.18 Please refer P.85 for cutting condition.

★For centre through tool coolant type, please add “-C” at the end of Code No. e.g. 26-RAC53-70K-C

CARTRIDGE for RAC BORING HEAD



B1

RAC Base () is common for all types of cartridges.

Please select suitable cartridge and insert tip for your application such as material and machining.

For Steel, Stainless Steel and Cast Iron
CC Insert (Positive type)



S.RCC-E Cartridge

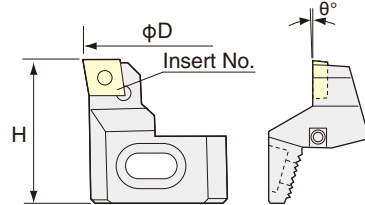

Set Code No.	Boring Range D	H	θ	Insert Code No.	
				Steel, Stainless Steel	Cast Iron
S.RCC- 25E	25 ~ 32	41	0°	CC08-C (AC630M)	CC08-C (AC410K)
				CC07-C (AC630M)	CC07-C (AC410K)
- 32E	32 ~ 45	41	+3°	CC08-C (AC630M)	CC08-C (AC410K)
- 43E	43 ~ 55	46		CC12-C (AC630M)	CC12-C (AC410K)
- 53E	53 ~ 70	50			
- 70E	70 ~ 100	55			
- 100E	100 ~ 130	57			

★Insert tips are supplied as an option.

☞ P.12 Please refer ☞ P.85 for cutting condition.

★Please order set of cartridges. e.g S.RCC-70E

★2 stepped balance cut with H=0.3 cartridge is also available. e.g. S.RCC-70E (0.3)

For Heavy Duty Boring of Iron and Cast Iron
CN Insert (Negative type)



S.RCC Cartridge

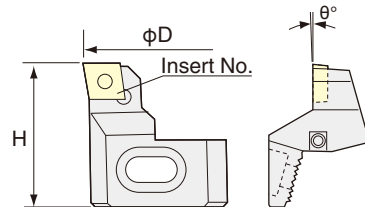

Set Code No.	D	H	θ	Insert Code No.	
				Iron and Cast Iron	
S.RCC- 43	43 ~ 55	46	-3°	CN08	
- 53	53 ~ 70	50			
- 70	70 ~ 100	55			
- 100	100 ~ 130	57			

★Insert tips are supplied as an option.

☞ P.14 Please refer ☞ P.85 for cutting condition.

★Please order set of cartridges. e.g S.RCC-70

★When CN08 insert (CN00120400) in the market is used, please use the eccentric bolt type cartridge (S.RCC-00Q) ☞ P.89. Nikken CN08-08 insert can be used on the eccentric bolt type cartridge.

★2 stepped balance cut with H=0.3 cartridge is also available. e.g. S.RCC-70 (0.3)

For Aluminum

S.RCC-A Cartridge

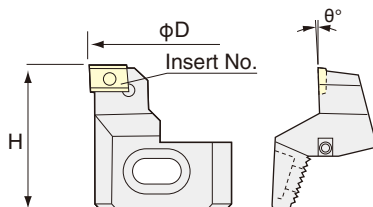

Set Code No.	D	H	θ	Insert Code No.	
				For Aluminum	
S.RCC- 25A	25 ~ 32	38	+6°	AEG12	
- 32A	32 ~ 45	41			
- 43A	43 ~ 55	46			
- 53A	53 ~ 70	50		AEG16	
- 70A	70 ~ 100	55			
- 100A	100 ~ 130	57			

★Insert tips are supplied as an option.

☞ P.16 Please refer ☞ P.85 for cutting condition.

★Please order set of cartridges. e.g S.RCC-70A

★2 stepped balance cut with H=0.3 cartridge is also available. e.g. S.RCC-70A (0.3)

★S.RCC-A cartridge can be used for the bottom face finishing of iron and cast iron.

For Through Hole and Multi Sheets

S.RCC-K Cartridge

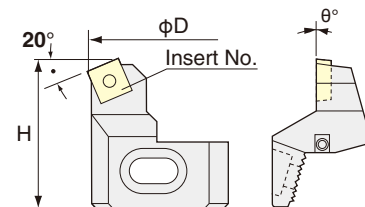

Set Code No.	D	H	θ	Insert Code No.	
				Steel, Stainless Steel	Cast Iron
S.RCC- 25K	25 ~ 32	41	0°	SC09-C (AC630M)	SC09-C (AC410K)
- 32K	32 ~ 45			SC12-C (AC630M)	SC12-C (AC410K)
- 43K	43 ~ 55				
- 53K	53 ~ 70	55			
- 70K	70 ~ 100	55			
- 100K	100 ~ 130	57			

★Insert tips are supplied as an option.

☞ P.18 Please refer ☞ P.85 for cutting condition.

★Please order set of cartridges. e.g S.RCC-70E

Dimension of RAC Base

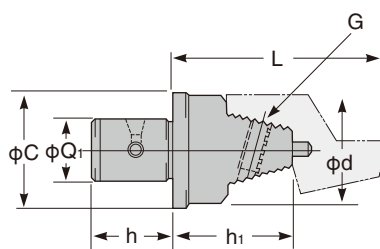

Code No.	Boring Range	h	h ₁	C	G	d
	D					
12-RAC 25- 55B	25~33	18	31	24	M5	23
12-RAC025- 55B						
16-RAC 32- 55B	32~45	22	31	31	M6	30
20-RAC 43- 70B	43~55	24	42	40		35
26-RAC 53- 70B	53~70	28	40	50	M8	45
26-RAC 70- 70B			38			60
34-RAC 70- 85B	70~100	36	53	64		60
42-RAC100-100B			66	83		70

★Dimension "L" is "58mm" in combination of RCC-25K and 12-RAC25-55B.

★For centre through tool coolant type except 26-RAC70-70B,

please add "-C" at the end of Code No. e.g. 34-RAC70-85B-C

RAC BALANCE-CUT BORING ARBOR for LARGE DIA.



For Roughing

- With the screws for slight adjustment
- Boring Dia. : $\phi 130 \sim \phi 580 \text{mm}$



RAC

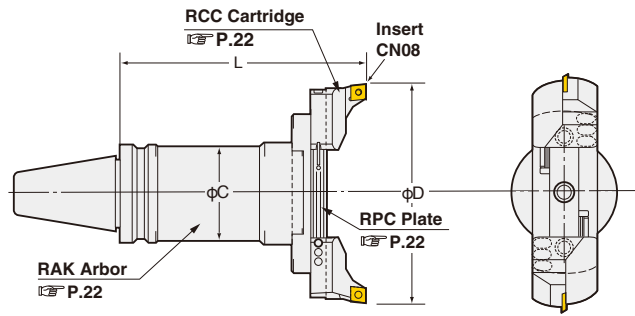

Boring Dia. : $\phi 130 \sim 580 \text{mm}$

TAPE	Code.No	D	L	C	RAK Arbor Code No.	RPC Plate No.	RCC Cartridge No.	Weight (Kg)			
		MIN.~MAX.									
No.40	BT40-RAC130-205	130~180	205	61	BT40-RAK-130A	RPC-130		7.0			
	(IT40)-RAC180-205	180~230						8.0			
No.50	BT50-RAC130-185	130~180	185	90	BT50-RAK-110A	RPC-130	For Heavy Duty Boring of Iron and Cast Iron	9.8			
	(IT50)-RAC130-235		235					-160A	12.5		
	-RAC130-285		285					-210A	15.2		
	-RAC130-335		335					-260A	17.9		
	-RAC130-385		385					-310A	20.6		
	-RAC130-435		435					-360A	23.3		
	-RAC130-485		485					-410A	26.0		
	-RAC180-185		185					-RAK-110A	10.4		
	-RAC180-235	235	-160A		13.1						
	-RAC180-285	285	-210A		15.8						
	-RAC180-335	335	-260A		18.5						
	-RAC180-385	385	-310A		21.2						
	-RAC180-435	435	-360A		23.9						
	-RAC180-485	485	-410A		26.6						
	-RAC230-185	185	-RAK-110A		11.1						
	-RAC230-235	235	-160A		13.8						
	-RAC230-285	285	-210A		16.5						
	-RAC230-335	335	-260A		19.2						
	-RAC230-385	385	-310A		21.9						
	-RAC230-435	435	-360A		24.6						
	-RAC230-485	485	-410A		27.3						
	-RAC280-185	185	-RAK-110A		11.7						
	-RAC280-235	235	-160A		14.4						
	-RAC280-285	285	-210A		17.1						
	-RAC280-335	335	-260A		19.8						
	-RAC280-385	385	-310A		22.5						
	-RAC280-435	435	-360A		25.2						
	-RAC280-485	485	-410A		27.9						
	-RAC330-210*	330~380	210 (220*)		98	BT50-RAK330-125 IT50-RAK330-135		RPC-330	RCC-130 x2 Insert Tip CN08	16.0	
	-RAC380-210*	380~430								-380	17.0
	-RAC430-210*	430~480								-430	18.0
	-RAC480-210*	480~530								-480	19.0
-RAC530-210*	530~580	-530		20.0							

★The Code No. on above table are the boring arbors with **RCC-130** cartridge (Insert tip: **CN08**) the Heavy Duty Boring of Iron and Cast Iron. Please refer **P.85** for cutting condition.

★Boring arbor with cartridges & insert for Steel, Stainless Steel and Cast Iron (**E**), for Aluminum (**A**) and for Through Hole & Multi Sheets (**K**) are available.

Please refer **P.22** for cartridges. e.g. **BT50-RAC130-185E**

★Please refer **P.22** for RAK arbor and RPC plate.

★Arbor, plate and cartridges are delivered in separate packages.

★Please check the interference of the arbor with your M/C not to occur the interference in the tool magazine.

★The location of the cutting edge is same as the drive key for standard. The different location is available, please specify θ . e.g. **BT50-RAC180-235-90°**

★For centre through tool coolant type, please add "-C" at the end of Code No. e.g. **BT50-RAC130-185-C**

★The boring arbors marked * with **IT50**, L (gauge length) is 220. e.g. **IT50-RAC330-220**

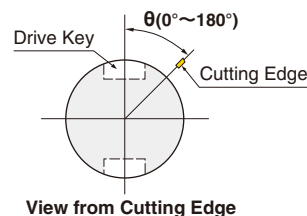

High Pressure Coolant Through Tool

MODULAR TYPE ARBOR



RAK BALANCE-CUT BORING ARBOR for LARGE DIA. <RAK Arbor>

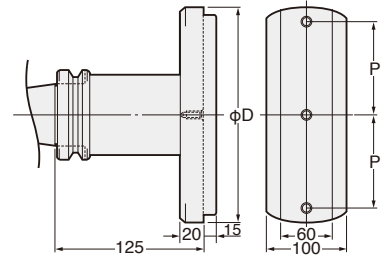
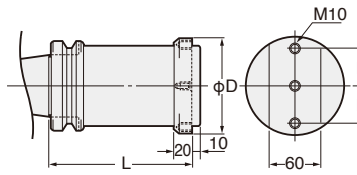

RAK

Fig.1

Fig.2

Code No.	Boring Range	L	D	P	Weight (Kg)	Applicable RPC Plate	Hex. Socket bolt	Fig.
BT40-RAK-130A (IT40)	130~230	130	102	35	4.9	RPC-130, 180	M1035	1
BT50-RAK-110A	130~330	110			7.2	RPC-130, 180, 230, 280		
(IT50)-RAK-160A		160			9.9			
-RAK-210A		210			12.6			
-RAK-260A		260			15.3			
-RAK-310A		310			18.0			
-RAK-360A		360			20.7			
-RAK-410A	410	23.4						
-RAK330-125*	330~580	125	240	100	12.0	RPC-330, 380, 430, 480, 530	M1045	2

★The location of the cutting edge is same as the drive key for standard. The different location is available, please specify θ . e.g. BT50-RAK-160A-90°
 ★For centre through tool coolant type, please add "C" at the end of Code No. e.g. BT50-RAK-160A-C 2 set of coolant nozzles are standard accessory.
 ★IT40-RAK-130 is available. ★* : In case of IT50, IT50-RAK-330-135 is standard gauge length.

BALANCE-CUT PLATE for LARGE DIA. <RPC Plate>

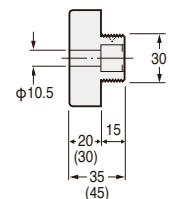
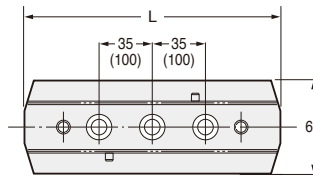

Dimensions in () are for RPC-330, 380, 430, 480 and 530.

Code No.	Boring Range	L	Weight (Kg)	Code No.	Boring Range	L	Weight (Kg)	Code No.	Boring Range	L	Weight (Kg)
RPC-130	$\phi 130 \sim 180$	118	1.4	RPC-330	$\phi 330 \sim 380$	316	5.3	RPC-530	$\phi 530 \sim 580$	516	8.7
-180	$\phi 180 \sim 230$	166	2.0	-380	$\phi 380 \sim 430$	366	6.1				
-230	$\phi 230 \sim 280$	216	2.7	-430	$\phi 430 \sim 480$	416	7.0				
-280	$\phi 280 \sim 330$	266	3.3	-480	$\phi 480 \sim 530$	466	7.9				

Accessories for RAC Balance-Cut Boring Arbor



Cartridge Lock Bolt

Please remove the bolt when using RAC-130 type for $\phi 130 \sim 157$ mm.

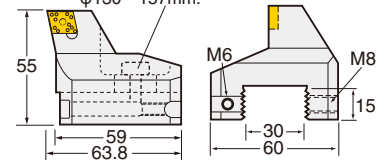

Weight : 0.6Kg

Accessories	Insert Tip	Clamp Bolt	Adjust Screw	Adjust Wrench	Wrench for Insert	Set Screw (M8)	L-Wrench for M815 Bolt	Hex Socket Bolt	Applicable RPC Plate
Code No.	*	CSM-70	M540	M3	20S	M815	M4	M625	RPC-130,180,230,280,330,380,430,480,530

★* : The insert tip is RCC-130: CN08 (P.14), RCC-130E: CC12 (P.12), RCC-130A: AEG16 (P.16), RCC-130K: SC12 (P.18)
 Please refer P.85 for cutting condition.

★There are two different types clamping system. One is eccentric system, the other is screw on system. Above parts are for screw on system.

★Code No. RCC-130 indicates a single cartridge. When ordering a pair cartridge, please appoint to us Code No. S.RCC-130.

★The Code No. of the cartridges for 2 stepped balance cut is SRCC-130(0.3).

★When CN08 insert (CN00120400) in the market is used, please use the eccentric bolt type cartridge (S.RCC-130Q).
 Nikken CN08-08 insert can be used on the eccentric bolt type cartridge.

ZMAC ADVANCED BORING ARBOR (ZMAC-V)



Boring for Finishing



ZMAC-V

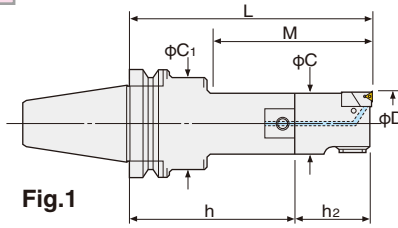

Fig.1

Only for ZMAC16-V

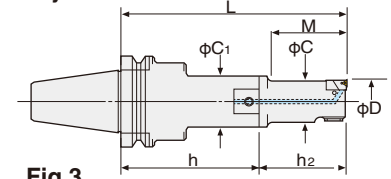

Fig.3

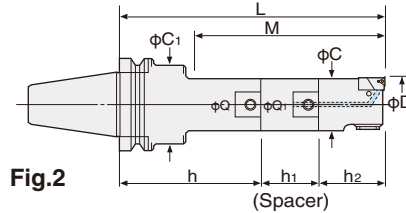

Fig.2

ZMAC100-V, 140-V

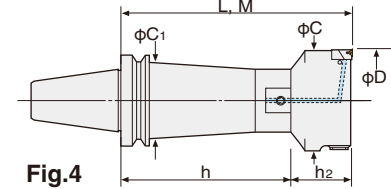

Fig.4

Code No. of the insert tip are shown.

TAPER	Code No.	Boring Range D	Boring Depth M	C	C1	Shank Code No.	Extension Spacer Code No.	P.88		Weight (kg)	Fig.	
								Head No.	Insert No.			
						BT No.-Q-h	Q-Q1-h1	Q- Min.D -h2				
No.40	BT40-ZMAC16 -125V	15.9~20.2	38	15	24	BT40-Q12- 80	-	-	12-ZMAC16-45V	3MP-C,B	1.9	3
	(IT40) -135V		48						12-ZMAC16-55V			
	-ZMAC20 -120V	19.8~25.2	45	19	30	-Q 9- 80	-	-	9-ZMAC20-40V	3MP-C,B	1.9	1
	-135V		67									
	-150V		75									
	-ZMAC25 -120V	24.8~32.2	52	24	35	-Q12- 80	-	-	12-ZMAC25-40V	4MP-C,B	2.0	1
	-150V		90									
	-165V		97									
	-ZMAC32 -150V	31.8~42.2	77	31	42	-Q16- 95	-	-	16-ZMAC32-55V	4MP-C,B	2.5	1
	-180V		110									
	-195V		122									
	-ZMAC42 -150V	41.8~55.2	97	40	50	-Q20- 80	-	-	20-ZMAC42-70V	6MP-C,B	3.0	1
	-180V		130									
	-210V		157									
	-ZMAC55 -165V	54.8~70.2	135	53	50	-Q26- 95	-	-	26-ZMAC55-70V	6MP-C,B	3.9	1
	-210V		180									
	-225V		195									
	-ZMAC70 -165V	69.8~85.2	165	67	64	-Q34- 95	-	-	34-ZMAC70-70V	6MP-C,B	5.4	1
	-180V		180									
	-225V		225									
-ZMAC85 -195V	84.8~100.2	195	83	62	-Q42- 95	-	-	42-ZMAC85-100V	6MP-C,B	6.8	2	
										9.0	1	

★MIN. dial readout : ZMAC25-V & smaller is 0.02mm on diameter. ZMAC32-V and larger are 0.01mm on diameter. (ZMAC25-V and larger : Sub scale : 0.005mm)

★“C” grade (Coated) insert for Steel, Stainless & Cast Iron is supplied as Standard with the head (Smooth boring & Long tool-life).

Please refer P.88 P.86 for cutting condition.

We would recommend “B” grade (CBN) insert for Hardened Steel & High Speed boring of Cast Iron.

★Please refer P.37 for Shank & Spacer, and P.38, P.27 for Head.

★Centre Through Tool Coolant function is available as standard.

★For BT30, modular connection system is applied. Please refer P.37 for Base Holder.

★When L length is required longer than standard, please specify boring depth M.

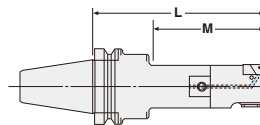

■ Boring Arbor with Extension Spacer

■ ZMAC-V for Multi-Stage Boring Bar P34,P.43

Please contact us for the special boring bar.



High Pressure Coolant Through Tool

ZMAC ADVANCED BORING ARBOR (ZMAC-V)



■ With ZMAC α -V Boring Head
Please add "AA" at the end of Code No.
e.g. BT40-ZMAC42-150AAV



ZMAC α -V

Diameter can be adjusted easily and quickly by new handle with wrench.



Unlock

Adjust diameter

Lock

Code No. of the insert tip are shown.

TAPER	Code No.	Boring Range D	Boring Depth M	C	C ₁	Shank Code No.	Extension Spacer Code No.	P.88		Weight (kg)	Fig.			
								Head No.	Insert No.					
								Q- Min.D -h ₂						
No.50	BT50-ZMAC16 -140V (IT50) -150V	15.9~20.2	38	15	24	BT50-Q12- 95	—	12-ZMAC16-45V	3MP-C,B	4.7	3			
	12-ZMAC16-55V		4.7											
	-ZMAC20 -150V	19.8~25.2	45	19	40	-Q 9-110	9-ZMAC20-40V	4.8	4.8	1				
	-165V		67			-Q 9-125N								
	-180V		75			-Q 9-110					SP9-9-30	4.9	2	
	-ZMAC25 -135V	24.8~32.2	52	24	44	-Q12- 95	12-ZMAC25-40V	4.8	4.8	1				
	-165V		90			-Q12-125								
	-180V		97			-Q12- 95					SP12-12-45	4.9	2	
	-ZMAC32 -180V	31.8~42.2	77	31	50	-Q16-125N	16-ZMAC32-55V	4MP-C,B	5.5	5.6	1			
	-210V		110			-Q16-155								
	-225V		122			-Q16-125N						SP16-16-45	5.7	2
	-ZMAC42 -180V	41.8~55.2	97	40	60	-Q20-110	20-ZMAC42-70V	6MP-C,B	6.0	6.0	1			
	-195V		130			-Q20-125								
	-225V		142			-Q20-110						SP20-20-45	6.4	2
	-240V		157			-Q20-110						SP20-20-60	6.5	
	-ZMAC55 -210V		54.8~70.2			117						53	65	-Q26-140
	-240V	182		-Q26-170N										
	-270V	177		-Q26-140	SP26-26-60	8.1	2							
	-ZMAC70 -240V	69.8~85.2	190	67	80	-Q34-170	34-ZMAC70-70V	10.0	10.6	1				
	-270V		220			-Q34-200								
	-300V		250			-Q34-170					SP34-34-60	11.5	2	
	-ZMAC85 -225V	84.8~100.2	182	83	83	-Q42-125	42-ZMAC85-100V	12.5	15.0	1				
	-290V		247			-Q42-190								
	-315V		272			-Q42-125					SP42-42-90	16.0	2	
	-ZMAC100-225V	99.5~140.5	225	95	98	-Q42-125	42-ZMAC100-100V	12.4	15.1	4				
	-290V		290			-Q42-190								
	-325V		325			-Q42-225A								
	-375V		375			-Q42-275A								
	-425V		425			-Q42-325A								
	-ZMAC140-225V	139.5~180.5	225	135	98	-Q42-125	42-ZMAC140-100V	13.8	16.5	4				
-290V	290		-Q42-190											
-325V	325		-Q42-225A											
-375V	375		-Q42-275A											
-425V	425		-Q42-325A											

★MIN. dial readout : ZMAC25-V & smaller is 0.02mm on diameter. ZMAC32-V and larger are 0.01mm on diameter.(ZMAC25-V and larger : Sub scale : 0.005mm)
 ★When L length is required longer than standard, please specify boring depth M. ★Centre Through Tool Coolant function is available as standard.
 ★"C" grade (Coated) insert for Steel, Stainless&Cast Iron is supplied as Standard with the head (Smooth boring & Long tool-life) . P.88
 We would recommend "B" grade (CBN) insert for Hardened Steel & High Speed boring of Cast Iron. Please refer P.86 for cutting condition.
 ★Please refer P.37 for Shank & Spacer,and P.38, P.28 for Head.

ZMAC ADVANCED BORING ARBOR (ZMAC-VR)



Boring for Semi-Finishing—ZMAC-VR



ZMAC-VR

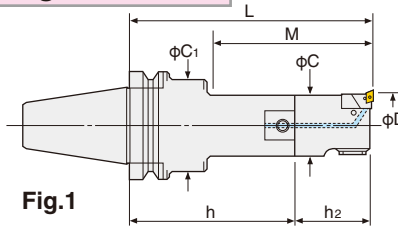

Fig.1

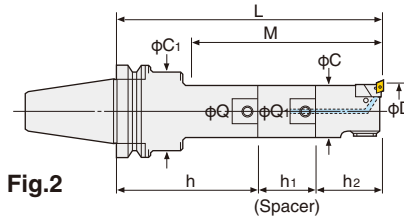

Fig.2

ZMAC100-VR, 140-VR

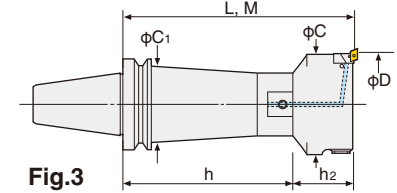



Fig.3

Code No. of the insert tip  are shown.

TAPER	Code No.	Boring Range D	Boring Depth M	C	C ₁	Shank Code No.	Extension Spacer Code No.	P.26		Weight (kg)	Fig.
								Head No.	Insert No.		
						BT No.-Q-h	Q-Q1-h1	Q- Min.D	-h2		
No.40	BT40-ZMAC32R -150V	31.8~42.2	77	31	42	BT40-Q16- 95	—	16-ZMAC32R-55V	CC06-C	2.5	1
	(IT40) -180V		110			-Q16-125				2.7	
	-195V		122			-Q16- 95				SP16-16-45	
	-ZMAC42R -150V	41.8~55.2	97	40	50	-Q20- 80	—	20-ZMAC42R-70V	CC06-C	3.0	1
	-180V		130			-Q20-110				3.2	
	-210V		157			-Q20- 80				SP20-20-60	
	-ZMAC55R -165V	54.8~70.2	135	53	50	-Q26- 95	—	26-ZMAC55R-70V	CC06-C	3.9	1
	-210V		180			-Q26-140				4.6	
	-225V		195			-Q26- 95				SP26-26-60	
	-ZMAC70R -165V	69.8~85.2	165	67	64	-Q34- 95	—	34-ZMAC70R-70V	CC08-C	5.4	1
	-180V		180			-Q34-110				5.8	
	-225V		225			-Q34- 95				SP34-34-60	
	-ZMAC85R -195V	84.8~100.2	195	83	62	-Q42- 95	—	42-ZMAC85R-100V	CC08-C	9.0	1

★MIN. dial readout : ZMAC25-VR & smaller is 0.02mm on diameter. ZMAC32-VR and larger are 0.01mm on diameter.(Sub scale : 0.005)

★“C” grade (Coated) insert for Steel, Stainless & Cast Iron is supplied as Standard with the head (Smooth boring & Long tool-life).

☞ P.26 Please refer ☞ P.86 for cutting condition.

We would recommend “B” grade (CBN) insert for Hardened Steel & High Speed boring of Cast Iron.

★Please refer ☞ P.37 for Shank & Spacer, and ☞ P.38, P.27,P28 for Head.

★Centre Through Tool Coolant function is available as standard.

★For BT30, modular connection system is applied. Please refer ☞ P.37 for Base Holder.

★When L length is required longer than standard, please specify boring depth M.

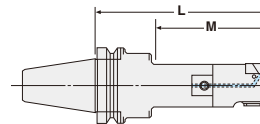

Boring Arbor with Extension Spacer



ZMAC-V for Multi-Stage Boring Bar ☞ P.34,P.43

Please contact us for the special boring bar.



High Pressure Coolant Through Tool

ZMAC ADVANCED BORING ARBOR (ZMAC-VR)



Insert Tip for ZMAC-VR

● : best ○ : good

Material	Steel	●	
	Stainless Steel	●	
	Cast Iron	○	●
	Aluminium		
	High Speed finish for Cast Iron		
	Hardened Steel		

Please add the grade indication into ○, and add the insert tip material indication at the end off the Code No. e.g. CC12-C8 (AC630M)

There is the CBN insert tip which both corners can be used. Please refer P.88 for ISO code of the insert tip.



Applicable Arbor	Dimension	Code No.	Nose R	Grade	
				Material	C
				Coated Carbide M	Coated Carbide K
				AC630M	AC410K
ZMAC32-VR, ZMAC42-VR, ZMAC55-VR		CCM0602ON	0.4	●	●
			0.8	●	●
			0.4	●	●
ZMAC70-VR, ZMAC85-VR		CCM09T3ON	0.4	●	●
			0.8	●	●
			0.4	●	●
ZMAC100-VR, ZMAC140-VR		CCM1204ON	0.4	●	●
			0.8	●	●
			0.8	●	●

Code No. of the insert tip are shown.

TAPER	Code No.	Boring Range D	Boring Depth M	C	C ₁	Shank Code No.	Extension Spacer Code No.	P.26		Weight (kg)	Fig.
								Head No.	Insert No.		
						BT No.-Q-h	Q-Q ₁ -h ₁	Q- Min.D -h ₂			
No.50	BT50-ZMAC32R -180V	31.8~42.2	77	31	50	BT50-Q16-125N	—	16-ZMAC32R-55V	CC06-C	5.5	1
	(IT50) -210V		110			-Q16-155	5.6				
	-225V		122			-Q16-125N	5.7				
	-ZMAC42R -180V	41.8~55.2	97	40	60	-Q20-110	—	20-ZMAC42R-70V	CC06-C	6.0	1
	-195V		130			-Q20-125	6.0				
	-225V		142			-Q20-110	6.4				
	-240V		157			SP20-20-45	6.5				
	-ZMAC55R -210V	54.8~70.2	117	53	65	-Q26-140	—	26-ZMAC55R-70V	CC06-C	7.5	1
	-240V		182			-Q26-170N	7.6				
	-270V		177			-Q26-140	8.1				
	-ZMAC70R -240V	69.8~85.2	190	67	80	-Q34-170	—	34-ZMAC70R-70V	CC08-C	10.0	1
	-270V		220			-Q34-200	10.6				
	-300V		250			-Q34-170	11.5				
	-ZMAC85R -225V	84.8~100.2	182	83	83	-Q42-125	—	42-ZMAC85R-100V	CC08-C	12.5	1
	-290V		247			-Q42-190	15.0				
	-315V		272			-Q42-125	16.0				
	-ZMAC100R-225V	99.5~140.5	225	95	98	-Q42-125	—	42-ZMAC100R-100V	CC12-C	12.4	3
	-290V		290			-Q42-190	15.1				
	-325V		325			-Q42-225A	17.8				
	-375V		375			-Q42-275A	20.5				
	-425V		425			-Q42-325A	23.2				
-ZMAC140R-225V	139.5~180.5	225	135	98	-Q42-125	—	42-ZMAC140R-100V	CC12-C	13.8	3	
-290V		290			-Q42-190	16.5					
-325V		325			-Q42-225A	19.2					
-375V		375			-Q42-275A	21.9					
-425V		425			-Q42-325A	24.6					

★MIN. dial readout : ZMAC32-VR and larger are 0.01mm on diameter.(Sub scale : 0.005)

★When L length is required longer than standard, please specify boring depth M.

★Centre Through Tool Coolant function is available as standard.

★“C” grade (Coated) insert for Steel, Stainless&Cast Iron is supplied as Standard with the head (Smooth boring & Long tool-life) . P.26

We would recommend “B” grade (CBN) insert for Hardened Steel & High Speed boring of Cast Iron. Please refer P.86 for cutting condition.

★Please refer P.37 for Shank & Spacer, and P.38, P.27,P28 for Head.

BT

MODULAR TYPE ZMAC ADVANCED BORING HEAD **NIKKEN**

ZMAC-V Triangular Insert type head

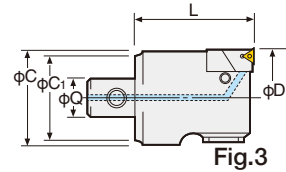
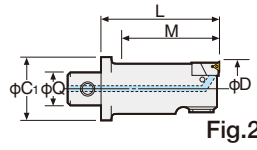
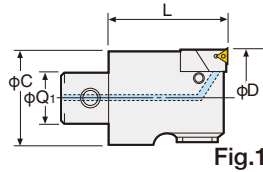

Head No.	Boring Range D	Boring Depth M	Coupling Dia. Q	Remarks					Weight (Kg)	
				C	C1	Unit No.	Insert No.	Fig.		
12-ZMAC 16- 45V	15.9~20.2	38	12	15	24	M 2HZ- 16V	3MP-C,B	2	0.4	
12-ZMAC 16- 55V		48							0.4	
9-ZMAC 20- 40V	19.8~25.2	40	9	19	24	M 2HZ- 20V	4MP-C,B	1	0.4	
12-ZMAC 25- 40V	24.8~32.2		12			M 3HZ- 25V			0.5	
16-ZMAC 32- 55V	31.8~42.2	55	16	31	-	M 4HZ- 32V	6MP-C,B	3	0.7	
20-ZMAC 42- 70V	41.8~55.2	20	40	M 5HZ- 42V		1.1				
26-ZMAC 55- 70V	54.8~70.2	70	26	53	-	M 5HZ- 55V	6MP-C,B	1	1.2	
34-ZMAC 70- 70V	69.8~85.2		34	67		M 7HZ- 70V			2.0	
42-ZMAC 85-100V	84.8~100.2	100	42	83	-	M10HZ- 85V	6MP-C,B	1	4.3	
42-ZMAC100-100V	99.5~140.5			95		83			M10HZ-100V	4.9
42-ZMAC140-100V	139.5~180.5			135					M10HZ-140V	6.3

★MIN. dial read out: ZMAC25-V and smaller is 0.02mm on dia.

ZMAC32-V and larger is 0.01mm on dia. (ZMAC25-V and larger : Sub scale : 0.005mm)

★The above boring ranges are based on heads with Nose/R 0.2 insert.

★“C” grade (Coated) insert for Steel, Stainless &

Cast Iron is supplied as Standard with the head (Smooth boring & Long tool-life).  P.88 Please refer  P.86 for cutting condition.

We would recommend “B” grade (CBN) insert for Hardened Steel & High Speed boring of Cast Iron.

★Centre Through Tool Coolant function is available as standard.

★Code No. of the set with SP26 stepped spacer is Q26-Coupling Dia.-ZMAC○-LengthV e.g. Q26-20-ZMAC42-100V

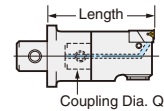

ZMAC-VR Rhomboid Insert type head

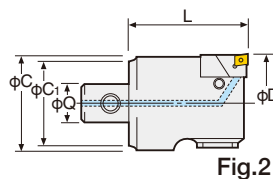
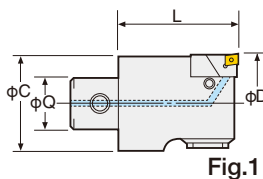

Head No.	Boring Range D	Boring Depth M	Coupling Dia. Q	Remarks					Weight (Kg)	
				C	C1	Unit No.	Insert No.	Fig.		
16-ZMAC 32R - 55V	31.8~42.2	55	16	31	-	M 4HZ- 32VR	CC06-C	1	0.7	
20-ZMAC 42R - 70V	41.8~55.2	20	40	M 5HZ- 42VR		1.1				
26-ZMAC 55R - 70V	54.8~70.2	70	26	53	-	M 5HZ- 55VR	CC08-C	1	1.2	
34-ZMAC 70R - 70V	69.8~85.2		34	67		M 7HZ- 70VR			2.0	
42-ZMAC 85R -100V	84.8~100.2	100	42	83	-	M10HZ- 85VR	CC12-C	2	4.3	
42-ZMAC 100R -100V	99.5~140.5			95		83			M10HZ-100VR	4.9
42-ZMAC 140R -100V	139.5~180.5			135					M10HZ-140VR	6.3

★MIN. dial read out: ZMAC32-VR and larger is 0.01mm on dia. (Sub scale : 0.005)

★“C” grade (Coated) insert for Steel, Stainless & Cast Iron is supplied as Standard with the head (Smooth boring & Long tool-life).

 P.26 Please refer  P.86 for cutting condition.

★Centre Through Tool Coolant function is available as standard.

★Code No. of the set with SP26 stepped spacer is Q26-Coupling Dia.-ZMAC○-LengthV e.g. Q26-20-ZMAC42R-100V

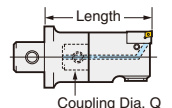

MODULAR TYPE ZMAC& ADVANCED BORING HEAD **NIKKEN**

For High Speed/Deep Hole Boring

ZMAC&-V  Triangular Insert type head

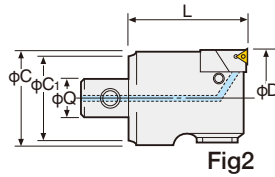
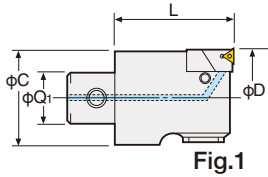

Head No.	Boring Range D	Boring Depth M	Coupling Dia. Q	Remarks					Weight (Kg)	
				C	C1	Unit No.	Insert No.	Fig.		
12-ZMAC 25- 40AAV	24.8~32.2	40	12	24		M 3HZ- 25V	3MP-C,B	1	0.4	
16-ZMAC 32- 55AAV	31.8~42.2	55	16	31		M 4HZ- 32V	4MP-C,B		0.5	
20-ZMAC 42- 70AAV	41.8~55.2	70	20	40		M 5HZ- 42V	6MP-C,B		0.8	
26-ZMAC 55- 70AAV	54.8~70.2		26	53		M 5HZ- 55V			0.7	
34-ZMAC 70- 70AAV	69.8~85.2		34	67		M 7HZ- 70V			1.1	
42-ZMAC 85-100AAV	84.8~100.2	100	42	83		M10HZ- 85V				2.3
42-ZMAC100-100AAV	99.5~140.5			95	83					M10HZ-100V
42-ZMAC140-100AAV	139.5~180.5			135	83			M10HZ-140V		3.1

★MIN. dial read out: ZMAC25&-V and smaller is 0.02mm on dia.

ZMAC32&-V and larger is 0.01mm on dia.(ZMAC25-V and larger : Sub scale : 0.005mm)

★The above boring ranges are based on heads with Nose/R 0.2 insert.

★“C” grade (Coated) insert for Steel, Stainless & Cast Iron is supplied as Standard with the head (Smooth boring & Long tool-life) .

 P.88 Please refer  P.86 for cutting condition.

We would recommend “B” grade (CBN) insert for Hardened Steel & High Speed boring of Cast Iron.

★Centre Through Tool Coolant function is available as standard.

★Code No. of the set with SP26 stepped spacer is Q26-Coupling Dia.-ZMAC&-Length AAV e.g. Q26-20-ZMAC42-100AAV

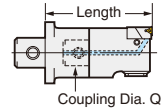

For High Speed/Deep Hole Boring

ZMAC& - VR  Rhomboid Insert type head

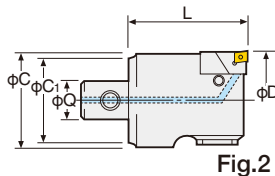
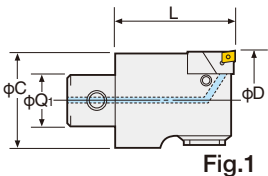

Head No.	Boring Range D	Boring Depth M	Coupling Dia. Q	Remarks					Weight (Kg)
				C	C1	Unit No.	Insert No.	Fig.	
16-ZMAC 32R - 55AAV	31.8~42.2	55	16	31		M 4HZ- 32VR	CC06-C	1	0.5
20-ZMAC 42R - 70AAV	41.8~55.2	70	20	40		M 5HZ- 42VR			0.8
26-ZMAC 55R - 70AAV	54.8~70.2		26	53		M 5HZ- 55VR			0.7
34-ZMAC 70R - 70AAV	69.8~85.2	100	42	34	67		CC08-C	2	1.1
42-ZMAC 85R -100AAV	84.8~100.2			83		M10HZ- 85VR			2.3
42-ZMAC 100R -100AAV	99.5~140.5			95	83		M10HZ-100VR		2.8
42-ZMAC 140R -100AAV	139.5~180.5	135	83		M10HZ-140VR	CC12-C	3.1		

★MIN. dial read out: ZMAC32&-VR and larger is 0.01mm on dia.(Sub scale : 0.005)

★“C” grade (Coated) insert for Steel, Stainless & Cast Iron is supplied as Standard with the head (Smooth boring & Long tool-life) .

 P.26 Please refer  P.86 for cutting condition.

We would recommend “B” grade (CBN) insert for Hardened Steel & High Speed boring of Cast Iron.

★Centre Through Tool Coolant function is available as standard.

★Code No. of the set with SP26 stepped spacer is Q26-Coupling Dia.-ZMAC&-Length AAV e.g. Q26-20-ZMAC42R-100AAV

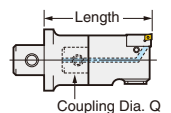

MODULAR TYPE ZMAC ADVANCED (ISO) BORING HEAD **NIKKEN**

ZMAC-V-I  Triangular Insert type head

These boring heads use insert tip sizes that are widely available on the market.
* Only insert clamp bolts are supplied (Insert tips are not supplied).

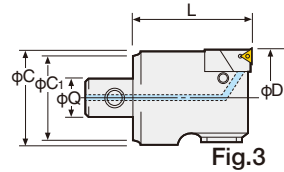
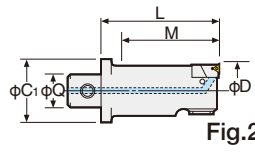
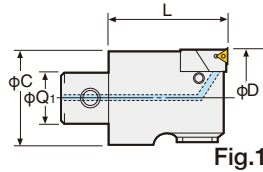

Head No.	Boring Range D	Boring Depth M	Coupling Dia. Q	Remarks						Weight (Kg)					
				C	C1	Unit No.	Insert No.	チップクランプボルトネジサイズ	Fig.						
16-ZMAC 32- 55V-I	31.8~42.2	55	16	31	-	M 4HZ- 32V-I	TC□□0902□□L	M2.2	1	0.7					
20-ZMAC 42- 70V-I	41.8~55.2		20	40		M 5HZ- 42V(M3)	TP□□1103□□L			M3	1.1				
26-ZMAC 55- 70V-I	54.8~70.2		26	53		M 5HZ- 55V(M3)					1.2				
34-ZMAC 70- 70V-I	69.8~85.2		34	67		M 7HZ- 70V(M3)					2.0				
42-ZMAC 85-100V-I	84.8~100.2	100	42	83	83	M10HZ- 85V(M3)	-	-	-	4.3					
42-ZMAC100-100V-I	99.5~140.5			95		M10HZ-100V(M3)				4.9					
42-ZMAC140-100V-I	139.5~180.5			135		-				-	-	-	-	-	6.3
															83

★MIN. dial read out: ZMAC32-V-I and larger is 0.01mm on dia. (Sub scale : 0.005)

★The above boring ranges are based on heads with Nose/R 0.2 insert.

★“C” grade (Coated) insert for Steel, Stainless & Cast Iron is supplied as Standard with the head (Smooth boring & Long tool-life).

 P.88 Please refer  P.86 for cutting condition.

We would recommend “B” grade (CBN) insert for Hardened Steel & High Speed boring of Cast Iron.

★Centre Through Tool Coolant function is available as standard.

★Code No. of the set with SP26 stepped spacer is Q26-Coupling Dia.-ZMAC○-LengthV-I e.g. Q26-20-ZMAC42-100V-I

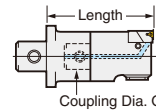

MODULAR TYPE ZMAC& ADVANCED (ISO) BORING HEAD **NIKKEN**

For High Speed/Deep Hole Boring

ZMAC&-V-I  Triangular Insert type head

These boring heads use insert tip sizes that are widely available on the market.
* Only insert clamp bolts are supplied (Insert tips are not supplied).

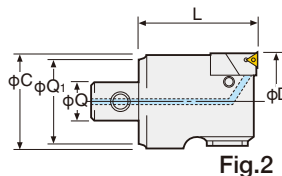
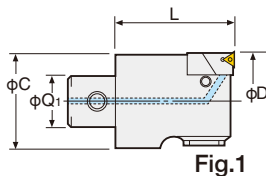

Head No.	Boring Range D	Boring Depth M	Coupling Dia. Q	Remarks						Weight (Kg)					
				C	C1	Unit No.	Insert No.	チップクランプボルトネジサイズ	Fig.						
16-ZMAC 32- 55AAV-I	31.8~42.2	55	16	31	-	M 4HZ- 32V-I	TC□□0902□□L	M2.2	1	0.5					
20-ZMAC 42- 70AAV-I	41.8~55.2		20	40		M 5HZ- 42(M3)	TP□□1103□□L			M3	0.8				
26-ZMAC 55- 70AAV-I	54.8~70.2		26	53		M 5HZ- 55(M3)					0.7				
34-ZMAC 70- 70AAV-I	69.8~85.2		34	67		M 7HZ- 70(M3)					1.1				
42-ZMAC 85-100AAV-I	84.8~100.2	100	42	83	83	M10HZ- 85(M3)	-	-	-	2.3					
42-ZMAC100-100AAV-I	99.5~140.5			95		M10HZ-100(M3)				2.8					
42-ZMAC140-100AAV-I	139.5~180.5			135		-				-	-	-	-	-	3.1
															83

★MIN. dial read out: ZMAC32&-V-I and larger is 0.01mm on dia. (Sub scale : 0.005)

★The above boring ranges are based on heads with Nose/R 0.2 insert.

★“C” grade (Coated) insert for Steel, Stainless & Cast Iron is supplied as Standard with the head (Smooth boring & Long tool-life).

 P.88 Please refer  P.86 for cutting condition.

We would recommend “B” grade (CBN) insert for Hardened Steel & High Speed boring of Cast Iron.

★Centre Through Tool Coolant function is available as standard.

★Code No. of the set with SP26 stepped spacer is Q26-Coupling Dia.-ZMAC○-Length AAV-I e.g. Q26-20-ZMAC42-100AAV-I

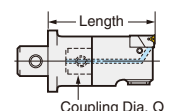

ZMAC ADVANCED (ISO) BORING UNIT PARTS LIST

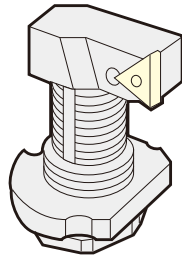

ZMAC-V-I

NIKKEN ZMAC-V-I Boring Heads come complete with the ZMAC-V-I Boring Unit. Specify the part No. in the table below when ordering spares. Triangular Insert Heads and Rhomboid Insert Heads use different boring units, cartridges, insert tips, insert clamp bolts, and insert clamp handles, but all other parts are common to both.

* The ZMAC units and new ZMAC-V-I units are interchangeable.

ZMAC-V-I Style	Boring Range	Unit	Triangular Insert	Insert Clamp Screw	Insert Clamp Handle	Lock Screw	Adjustment Handle	Unit Clamp Bolt
ZMAC 32-V-I	31.8~42.2	M 4HZ- 32V-I	TC□□0902□□L	M2255	T-6	M365	M 4HZL	M2577
ZMAC 42-V-I	41.8~55.2	M 5HZ- 42V(M3)	TP□□1103□□L	M3070	T-10	M364	M 5HZL	
ZMAC 55-V-I	54.8~70.2	M 5HZ- 55V(M3)				M366	M3090	
ZMAC 70-V-I	69.8~85.2	M 7HZ- 70V(M3)				M360		
ZMAC 85-V-I	84.8~100.2	M10HZ- 85V(M3)				M367		
ZMAC 100-V-I	99.5~140.5	M10HZ-100V(M3)				M368		M10HZL
ZMAC 140-V-I	139.5~180.5	M10HZ-140V(M3)				M369		

★Each Unit and Cartridge are supplied without Insert Tip.



Special cartridge example for necking is available. Please contact us with the work piece drawing.

ZMAC-VR Style	Boring Range	Unit	Triangular Insert (ISO code)	Insert Clamp Screw	Insert Clamp Handle
ZMAC 32-VR	31.8~42.2	M 4HZ- 32VR	CC06-C (CC□□0602□□)	M2560	T-8
ZMAC 42-VR	41.8~55.2	M 5HZ- 42VR		M2577	
ZMAC 55-VR	54.8~70.2	M 5HZ- 55VR	CC08-C (CC□□09T3□□)	M4090	T-15
ZMAC 70-VR	69.8~85.2	M 7HZ- 70VR		M4012	
ZMAC 85-VR	84.8~100.2	M10HZ- 85VR	CC12-C (CC□□1204□□)	M5012	T-15
ZMAC 100-VR	99.5~140.5	M10HZ-100VR			
ZMAC 140-VR	139.5~180.5	M10HZ-140VR			

The cartridge head can be exchanged itself for the head bigger equal to ZMAC42-V.

Boring Range	Cartridge Head		Head Clamp Bolt
	Triangular	Rhomboid	
41.8~55.2	M 5HZ- 42 CH (M3)	M 5HZ- 42RCH	M512C
54.8~70.2	M 7HZ- 70 CH (M3)	M 7HZ- 70RCH	
69.8~85.2	M 10HZ- 85 CH (M3)	M 10HZ- 85RCH	
84.8~100.2	M 10HZ- 100 CH (M3)	M 10HZ- 100RCH	
99.5~140.5			
139.5~180.5			

★Each Unit and Cartridge are supplied without Insert Tip.
★Cartridge can not be supplied alone, please order ZMAC-V unit.

- Detach**
- Loosen head clamp bolt after boring diameter is set to little larger than the MIN. boring diameter.
- Attach**
- Insert the head into cartridge, then tighten head clamp bolt temporary.
 - Loosen side lock bolt.
 - Rotate the dial ring 0.2~0.3mm to minus direction.
 - Tighten head clamp bolt by pushing the head to the support portion of the main body.

■ INSERT TIP (please refer to the ISO code below to purchase.)

ZMAC-V-I Style	Dimension	ISO code
ZMAC32-V-I		TC□□0902□□L
ZMAC42-V-I ZMAC140-V-I		TP□□1103□□L

■ Code No. of ISO standard Insert Tip

T P G T 1 1 0 3 0 4 L

T : Triangle Normal Clearance
 W : 80°
 C : 80°
 M : 86°
 S : 90°
 A : 85°
 B : 5°
 C : 7°
 P : 11°
 N : 0°
 E : 20°
 G : Ground
 M : Pressed
 Tolerance Class
 Tip Breaker & Hole Configuration
 L : Left Direction
 N : Either

BALANCE-CUT BAC ADVANCED BORING ARBOR for LARGE DIA. **NIKKEN**

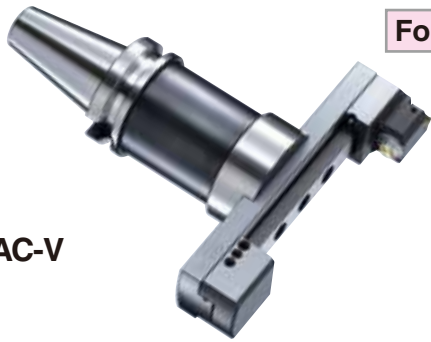

BAC-V

For Finishing

- MIN. dial readout on dia. : 0.01mm (Sub scale : 0.005)
- Boring Dia : $\phi 130 \sim \phi 595\text{mm}$

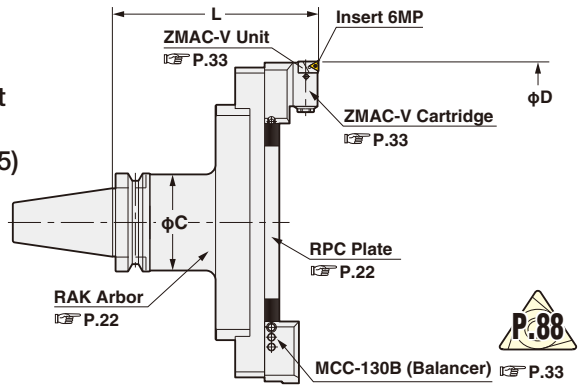

Boring Dia: $\phi 130 \sim 595\text{mm}$

TAPER	Code.No	D		L	C	RAK Arbor Code No.	PPC Plate No	Cartridge (Balancer)	Weight (Kg)					
		MIN.	MAX.											
No.40	BT40-BAC130-205V	130	195	205	61	BT40-RAK-130A	RPC-130	MCCZ-130V (MCC-130B) Insert 6MP	7.0					
	(IT40)-BAC180-205V	180	245						8.0					
	No.50	BT50-BAC130-185V	130	195	185	90	BT50-RAK-110A		RPC-130	10.0				
		(IT50) -235V			235					12.7				
		-285V			285					15.4				
		-335V			335					18.1				
		-385V			385					20.8				
		-435V			435					23.5				
		-485V			485					26.2				
		-BAC180-185V			185					10.6				
		No.50	-235V	180	245		235		90	-RAK-110A	RPC-180	13.3		
			-285V				285					16.0		
			-335V				335					18.7		
			-385V				385					21.4		
			-435V				435					24.1		
			-485V				485					26.8		
			No.50	-BAC230-185V	230		295			185	90	-RAK-110A	RPC-230	11.3
				-235V						235				14.0
				-285V						285				16.7
				-335V						335				19.4
-385V	385			22.1										
-435V	435			24.8										
No.50	-485V	280		345	485	98	-RAK-110A	RPC-280	27.5					
	-BAC280-185V				185				11.9					
	-235V				235				14.6					
	-285V				285				17.3					
	No.50	-335V		330	395		335	98	BT50-RAK330-125 IT50-RAK330-135	RPC-330		20.0		
		-385V					385					22.7		
		-435V	435				25.4							
		-485V	485				28.1							
		-BAC330-210V*	330				16.7							
		-BAC380-210V*	380				17.0							
No.50	-BAC430-210V*	530	595	430	98	BT50-RAK330-125 IT50-RAK330-135	RPC-330	18.0						
	-BAC480-210V*			480				19.0						
	-BAC530-210V*			530				20.0						
	-BAC430-210V*			430				18.0						
	-BAC480-210V*			480				19.0						

★“C” grade (Coated) Inserts are supplied as standard. P.88 Please refer P.86 for cutting condition.

★Unit “M5HZ-55V” is provided as standard, please refer P.22 for Arbor (RAK) and Plate (RPC).

★Arbor, Plate and Cartridge are delivered in separate packages.

★When ordering, please let us know machine maker and model no. to avoid the interference with tool magazine of ATC.

★The location of cutting edge is same as drive key in standard.

The different location is available, please specify θ in Code No. e.g. BT50-BAC180-235V-90°

★The boring arbors marked * with IT50,

L (gauge length) is 220. e.g. IT50-BAC330-220V

★For centre through tool coolant type, please add “-C” at the end of Code No. e.g. BT50-BAC130-185V-C

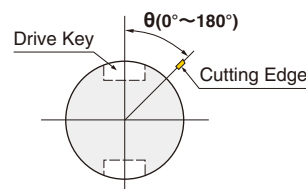

View from Cutting Edge



High Pressure Coolant Through Tool

BALANCE-CUT BCB BORING ARBOR for LARGE DIA.



BCB

For Roughing / Finishing

- MIN. dial readout on dia. : 0.02mm (Sub scale : 0.002)
- Boring Dia : $\phi 130 \sim \phi 595\text{mm}$

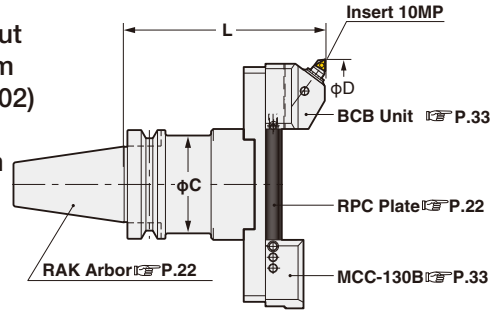

Boring Dia: $\phi 130 \sim 595\text{mm}$

TAPER	Code.No	D		L	C	RAK Arbor Code No.	RPC Plate No	Cartridge (Balancer)	Weight (Kg)					
		MIN.	MAX.											
No.40	BT40-BCB130-215	130	195	215	61	BT40-RAK-130A	RPC-130	BCB-130 (MCC-130B) Insert 10MP	7.5					
	(IT40)-BCB180-215	180	245				-180		8.5					
	No.50	BT50-BCB130-195	130	195	195	90	BT50-RAK-110A		RPC-130	10.3				
		(IT50)-245								245	-160A	13.0		
		-295								295	-210A	15.7		
		-345								345	-260A	18.4		
		-395								395	-310A	21.1		
		-445								445	-360A	23.8		
		-495								495	-410A	26.5		
		-BCB180-195								180	195	195	90	BT50-RAK-110A
-245		245						-160A						
-295		295	-210A	16.3										
-345		345	-260A	19.0										
-395		395	-310A	21.7										
-445		445	-360A	24.4										
-495		495	-410A	27.1										
-BCB230-195		230	195	195	90	BT50-RAK-110A	RPC-230	11.6						
-245								245	-160A	14.3				
-295								295	-210A	17.0				
-345								345	-260A	19.7				
-395	395							-310A	22.4					
-445	445							-360A	25.1					
-495	495	-410A	27.8											
-BCB280-195	280	195	195	98	BT50-RAK-110A	RPC-280	12.2							
-245							245	-160A	14.9					
-295							295	-210A	17.6					
-345							345	-260A	20.3					
-395							395	-310A	23.0					
-445							445	-360A	25.7					
-495	495	-410A	28.4											
-BCB330-220*	330	395	220 (220*)	98	BT50-RAK330-125 IT50-RAK330-135	RPC-330	16.5							
-BCB380-220*	380	445				-380	17.5							
-BCB430-220*	430	495				-430	18.5							
-BCB480-220*	480	545				-480	19.5							
-BCB530-220*	530	595				-530	20.5							

★10MP-T (Cermet) is supplied as standard. P.88 Please refer P.86 for cutting condition.

★MIN. dial readout on dia.: 0.02mm, Sub scale: 0.002mm

★The boring arbor marked * with IT50, L (gauge length) is 220. e.g. IT50-BCB330-220.

Up to $\phi 800$ is also available. Please contact with us.

Double Cut Style BCB Boring Bar



BCB-W

- ★Double cut style can be done with both side of BCB-130 cartridges. Please add "W" at the end of Code No. e.g. BT50-BCB130W-195
- True balance cut can be done to adjust the height by micro adjustment first and then to adjust the diameter by adjust screw.
- Stepped cut can be done to change the height of the cartridges.

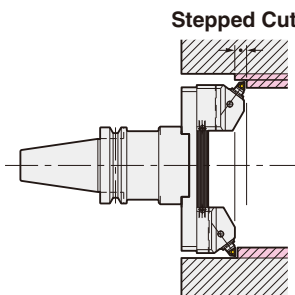

Accessories for Balance-Cut BAC-V

Balance-Cut MAC type cartridge for large dia.

MAC type Balancer for Balance-Cut large dia.

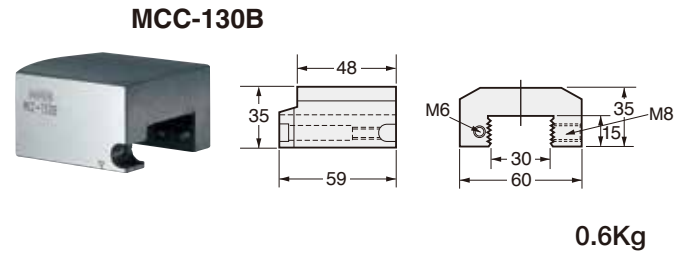
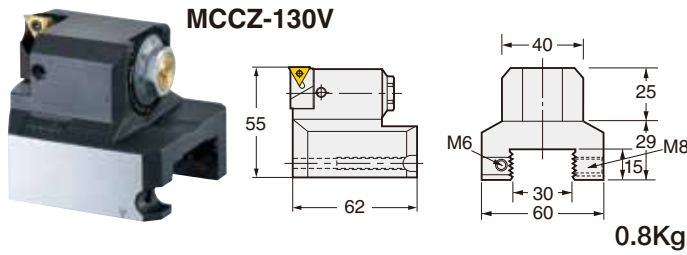

Accessories	ZMAC-V Unit	Insert Tip	Clamp Bolt	Wrench for Insert	Lock Screw	Adjust Screw	Set Screw (M8)	L-Wrench for M815 Belt	Adjust Wrench	Adjustment Handle	Applicable RPC Plate
Code No.	M5HZ-55V	6MP-C	M2577	T-8	M366	M540	M815	M4	M3	M5HZL	RPC-130,180,230,280,330,380,430,480,530

★Please refer [P.22](#) for RPC Plate. ★Set Code No. is **S.MCCZ-130V**.
 ★M5HZ-55VR with CC06-C insert tip is available. Please specify code No. **S.MCCZ-130VR**.
 ★6MP-C insert tip is supplied as standard. [P.88](#) Please refer [P.86](#) for cutting condition.

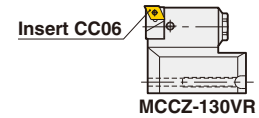

Accessories for Balance-Cut BCB

Balance-Cut BCB type cartridge for large dia.

MAC type Balancer for Balance-Cut large dia.

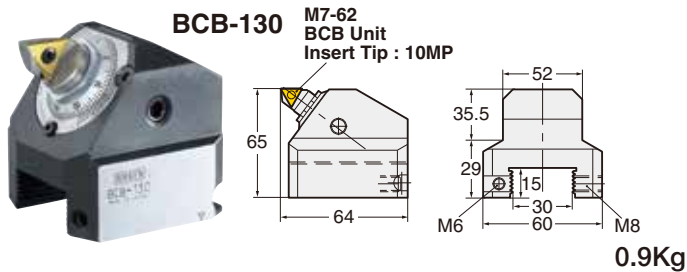

Accessories	BCB Unit	Insert Tip	Clamp Bolt	Wrench for Insert	Lock Screw	Adjust Screw	Set Screw (M8)	L-Wrench for M815 Belt	Adjust Wrench	Adjustment Handle	Applicable RPC Plate
Code No.	M7-62	10MP-T	M67	20S	B357, B367	M540	M815	M4	M3	M397	RPC-130,180,230,280,330,380,430,480,530

★Please refer [P.72](#) for RPC Plate. ★Set Code No. is **S.BCB-130**.
 ★10MP-T insert tip is supplied as standard. [P.88](#) Please refer [P.86](#) for cutting condition.

SPECIAL DESIGNED BORING ARBOR

NIKKEN

There exist various kinds of boring applications which cannot be managed using standard boring arbors. NIKKEN has great experience of special boring applications, utilizing the double contact shoulder support **ZMAC-V** boring heads. NIKKEN can also design and manufacture special boring arbors to suit your special applications.



RAA

Base Arbor for Special Boring Head

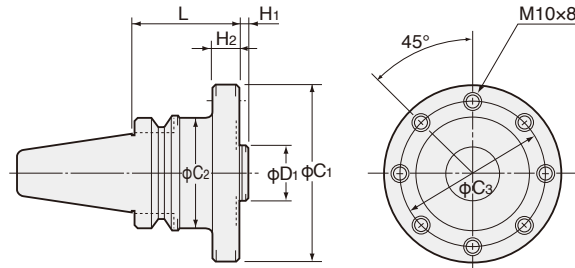

For Overturning

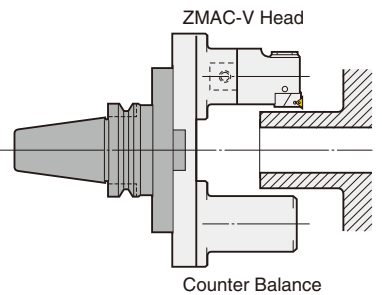

For U Axis Boring Arbor

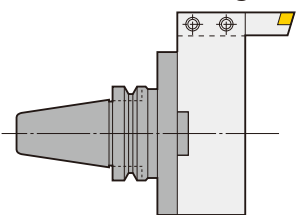

TAPER	Code No.	D ₁	L	H ₁	H ₂	C ₁	C ₂	C ₃	Weight (kg)
No.40	BT40-RAA32- 60 (IT40)	32 h7	60	7	15	102	61	82	2.5
	No.50		BT50-RAA32- 60 (IT50)		60				
-120			120		20				
-180			180	15.5					

- ★The Base Holder with long gauge length is available on demand.
- ★High Pressure Centre Through Tool Coolant Type is available on demand.
- ★The dimension with () is for IT40 and IT50.
- ★For BT40, φD₁=22mm is also available.

Multi Stage Boring Arbor

For Simultaneous machining for rough, finish and chamfer.

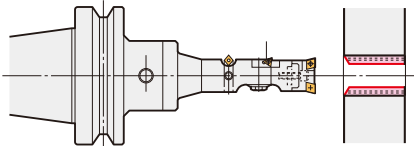

Please specify the boring dia., depth, and necessary length from the gauge line.

For stepped hole boring with restricted concentricity.

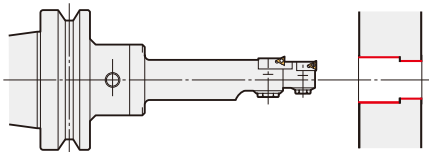

Please specify each boring dia., depth, and necessary length from the gauge line.

For decreasing the number of A.T.C with one arbor for two different size of the bores.

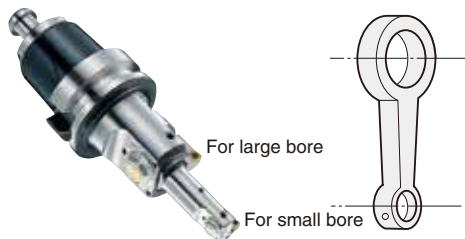

Photo shows with NC5 Shank.

The above are just samples. Pre-Balanced type Boring Arbor for High Speed Application and Aluminium Body Head are also available. Please contact with us about your special boring applications.

DRILLING OPERATION by COMBAT Z DRILL



“Rationalization is Study of Drilling.” which is our Slogan for developing **NIKKEN COMBAT ZDRILL.** NC TOTAL TOOLING SYSTEM P.271 Please try it. Pilot Drill and 3-Phases Heat Treatment significantly improves Cutting Condition, Secure Drilling and Tool Life.

Ultra Long Size Boring Bar

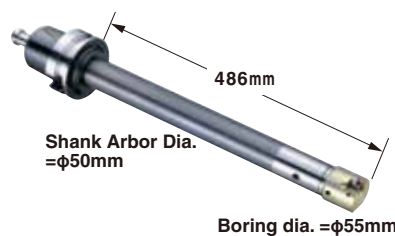
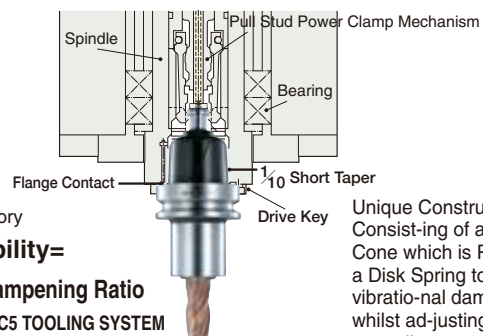

Photo shows with NC5 Shank.

For Extreme Deep Hole Boring Operation, please study the Machine with **NC5 Spindle P.55** or **3LOCK Spindle P.45**. In case of BT/IT spindle, we recommend **ZMAC α-V** type Head for these applications.



E · H · MERRITT's Theory

Chattering Stability=

Static Stiffness × Dampening Ratio

Thus, the advantage of NC5 TOOLING SYSTEM is clearly demonstrated.

Unique Construction : Consist-ing of a Slotted Taper Cone which is Pre-Loaded by a Disk Spring to increase its vibratio-nal dampening effect whilst ad-justing minute gaugeline errors, completely.

BT

DJ BORING BAR



High Pressure Coolant Through Tool is available. Please contact us.

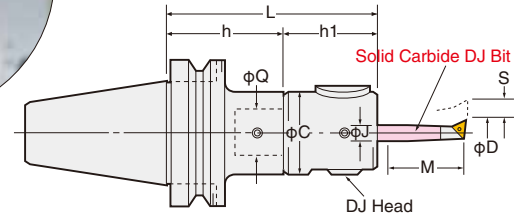

BT-DJ

TAPER	Code No.	Boring Range	Boring Depth	L	C	Bit Hole Size	Shank Code No.	Head Code No.	Bit Stroke	DJ Bit Code No.	Weight (Kg)
		D	M								
No.30	BT30-DJ3- 80	3~28	14~ 80	80	50	10	BT30-Q26- 40	Q26-DJ3-40A	5.2	J10	1.0
	-DJ8- 84AN	3~50	14~130	84	59	16		-DJ8-44AN	6.0	J16	1.2
No.40	BT40-DJ3- 90A	3~28	14~ 80	90	50	10	BT40-Q26- 50	Q26-DJ3-40A	5.2	J10	1.6
	(IT40) -135A			135							
	-DJ8- 94AN	3~50	14~130	94	59	16	BT40-Q26- 50	-DJ8-44AN	6.0	J16	1.9
	-139AN			139							
No.50	BT50-DJ3-105A	3~28	14~ 80	105	50	10	BT50-Q26- 65	Q26-DJ3-40A	5.2	J10	4.2
	(IT50) -210A			210							
	-DJ8-109AN	3~50	14~130	109	59	16	BT50-Q26- 65	-DJ8-44AN	6.0	J16	4.5
	-214AN			214							

- ★MIN. dial readout on dia.: 0.01mm, Sub scale: 0.005mm, 0.8mm/rev.
- ★Each boxed set of DJ3 and DJ8 Boring Bars include 4 pcs of DJ Boring Bits as standard.
- ★Bits included for BT40-DJ8-94A : J16-8-40, J16-18-80, J16-28-85, J16-38-85
- Bits included for BT40-DJ8-94AN : J16-8-40, J16-18-60, J16-28-65, J16-38-65
- ★DJ Boring Bar without Boring Bits is also available. Please add “-BD” at the end of Code No. e.g. BT40-DJ3-90A-BD
- ★Shank and DJ Head (including Boring Bits) are delivered in separate packages.
- ★Please refer P.36 for Boring Bits. Please refer P.87 for cutting condition.

DJ BORING HEAD with DJ BORING BIT



DJ

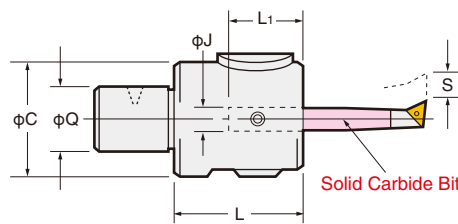

Easy to Set Micron Accuracy

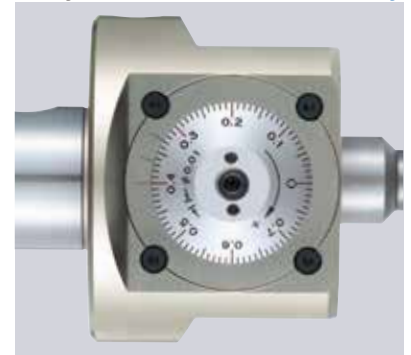

▲1 Graduation:0.01mm on dia.

DJ No.	Code No.	Boring Range	Boring Depth	Q	L	C	Bit Hole Size	L ₁	Bit Stroke	Weight (kg)	Bit Code No. (Standard Accessories)	Insert Tip Code No.
		D	M									
DJ3	Q26-DJ3-40A	3~28	14~80	26	40	50	10	27	5.2	0.5	J10- 3-14	—
											J10- 5-35	CC03-C
											J10- 8-40	3MP-C
											J10-18-62A	6MP-C
DJ8	Q26-DJ8-44AN	3~50	14~130	26	44	59	16	32	6.0	0.8	J16- 8-40	3MP-C
											J16-18-60	6MP-C
											J16-28-65	
											J16-38-65	

- ★MIN. dial readout on dia.: 0.01mm, Sub scale: 0.005mm, 0.8mm/rev.
- ★Each boxed set of DJ3 and DJ8 Boring Bars include 4 pcs. of DJ Bits, Insert, Insert Clamp Handle, (T6, T8, (10S for DJ3)) Micro Adjusting Handle (M2.5) as standard.
- ★Bits included for Q26-DJ8-44A : J16-8-40, J16-18-80, J16-28-85, J16-38-85
- Bits included for Q26-DJ8-44AN : J16-8-40, J16-18-60, J16-28-65, J16-38-65
- ★Please refer P.36 for Boring Bits. Please refer P.87 for cutting condition.
- ★DJ Boring Head without Bits is also available. Please add “-BD” at the end of Code No. e.g. Q26-DJ3-40A-BD, Q26-DJ8-44A-BD
- ★Weight of wooden box of DJ head with Boring Bits
 Q26-DJ3-40A : 1.2kg
 Q26-DJ8-44AN : 2.2kg
 Q26-DJ8-44A : 2.5kg

DJ BORING BIT SOLID CARBIDE

NIKKEN



New Bit Series for DJ8

Explanation of the Code No.
J - Abbreviation of DJ Bit.
16 - Dia. of Shank.
5 - Min. Boring Dia.
35 - Boring Depth(mm)

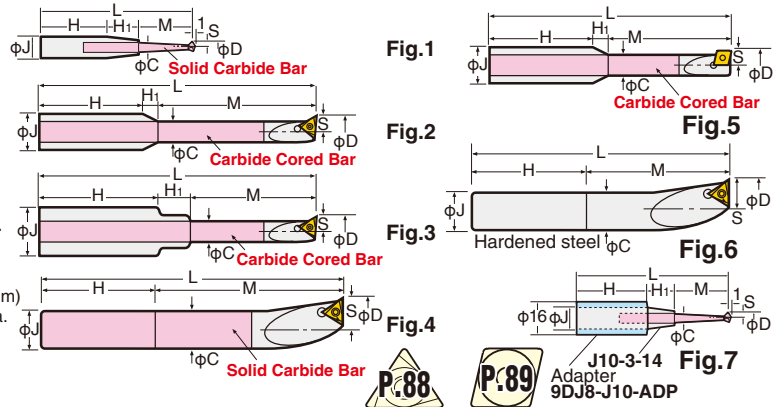

Style	Code No.	Boring Range		Boring Depth		J	L	H	H ₁	C	S	Insert No.	Insert Clamping Bolt No.	Insert Clamping Handle No.	Fig.	Weight (g)											
		D	M	D	M																						
DJ3	J10- 3- 14	3~ 8	14	10	62	30	18	2.2	1.5	-	-	-	-	-	1	30											
	- 5- 30*	5~15	30		60		-	4.3	2.5								CC03-C	M611	10S	5	28						
	- 5- 35		35		70		5.0	4.3	2.5													3MP-C	M2040	T-6	2	50	
	- 8- 35*	8~18	35		65	-	7.2	4.0	-	-	-	-	-	-	-	-	43										
	- 8- 40		40		75	32.5												2.5	7.2	4.0	6MP-C	M2577	T-8	4	110		
	- 8- 55*		55		90	26												-	12	9.0						130	
	-12- 40*	12~22	40		70	30	10	6.0	-	-	-	-	-	-	-	-	-	80									
	-12- 55*		55		85	26													10	6.0	100						
	-18- 65*	18~28	65		91	26	16	-	-	-	-	-	-	-	-	-	-	-	130								
	-18- 50A*		50		79	29														-	12	9.0	6MP-C	M2577	T-8	4	110
	-18- 62A*		62		91	29														-	12	9.0					
-18- 80*	80		106	26	106	26														29	130						
-18- 77A*	77		106	29	106	29														29		130					
J10- 3- 14*	3~ 8	14	10	62	30	18	2.2	1.5	-	-	-	-	-	-	7	30											
J16- 5- 25*	5~15	25	60	31.5	3.5	4.3	2.5	CC03-C	M611	10S	5	76															
- 5- 35*	5~15	35	78	33	10	4.3	2.5	CC03-C	M611	10S	5	80															
- 8- 35*		35	70	32.5	2.5	7.2	4.0						3MP-C	M2040	T-6	2	90										
- 8- 40		40	83	32	10	7.2	4.0											3MP-C	M2040	T-6	3	100					
- 8- 55*	8~18	55	98	32	10	7.2	4.0	3MP-C	M2040	T-6	3	110															
-12- 50*		50	90	35	-	11.2	6.0						M2045	T-6	2	140											
-12- 60*	60	103	40.5	2.5	11.2	6.0	M2045	T-6	2	170																	
-18- 60	60	93	-	-	9.0	6MP-C					M2577	T-8	6	150													
-18- 80	80	113	-	-	9.0		6MP-C	M2577	T-8	6					300												
-18-100*	100	133	-	-	16	14.0					M2577	T-8	4	350													
-18-120*	120	153	-	-	16		14.0	M2577	T-8	4					400												
-28- 65	65	98	-	-	16	14.0					M2577	T-8	6	150													
-28- 85	85	118	-	-	16		14.0	M2577	T-8	6					300												
-28-100*	100	133	-	-	16	14.0					M2577	T-8	4	350													
-28-130*	130	163	-	-	16		14.0	M2577	T-8	4					450												
-38- 65	65	98	-	-	19.0	19.0					M2577	T-8	6	200													
-38- 85	85	118	-	-	19.0		19.0	M2577	T-8	4					350												
-38-100*	100	133	-	-	23	16					M2577	T-8	4	370													
-38-130*	130	163	-	-	16		16	M2577	T-8	4					470												

- ★The Bits marked * are optional accessories. ★Please refer P.88 for boring bits. Please refer P.87 for cutting condition.
- ★9DJ8-J10-ADP adapter option is necessary to use J10-3-14 for DJ8 head.
- ★The shorter bits are added for J10-5, J10-8, J10-12 and J10-18. ★The shorter bits are added for J16-5, J16-8 and J16-12.
- ★“C” grade (Coated) insert tip is supplied. Please refer P.87 for cutting condition.
- ★Coolant through tool is basically available for the boring bits with MIN. boring diameter is φ12mm. e.g. J16-12-60C Please contact us.
- ★* 1 means bits for old type DJ3. ★* 2 means bits for new type DJ8. It can be used for old type DJ8, but M will be 3mm longer than above figure. e.g. J10-18-65A

Oil Hole Bit

Style	Code No.	Boring Range		Boring Depth		J	L	H	H ₁	C	S	Insert No.	Insert Clamping Bolt No.	Insert Clamping Handle No.	Fig.	Weight (g)				
		D	M	D	M															
DJ3	J10-12- 40C	12~22	40	10	70	30	-	10	6.0	3MP-C	M2040	T-6	4	80						
	-12- 55C		55		85										100					
	-18- 65C	18~28	65		26	12									9.0	6MP-C	M2577	T-8	4	130
	-18- 80C		80																	
DJ8	J16-12- 50C	12~22	50	16	90	35	-	11.2	6.0	3MP-C	M2045	T-6	2	140						
	-12- 60C		60		103										2.5	40.5	11.2	6.0	6MP-C	M2577
	-18- 60C	60	93		-	-	9.0	6MP-C	M2577	T-8	6	150								
	-18- 80C	80	113		-	-	9.0						6MP-C	M2577	T-8	4	300			
	-18-100C	100	133		-	-	16	14.0	M2577	T-8	4	350								
	-18-120C	120	153		-	-	16						14.0	M2577	T-8	4	400			
	-28- 65C	65	98		-	-	16	14.0	M2577	T-8	6	150								
	-28- 85C	85	118		-	-	16						14.0	M2577	T-8	6	300			
	-28-100C	100	133		-	-	16	14.0	M2577	T-8	4	350								
	-28-130C	130	163		-	-	16						14.0	M2577	T-8	4	450			
	-38- 65C	65	98		-	-	19.0	19.0	M2577	T-8	6	200								
	-38- 85C	85	118		-	-	19.0						19.0	M2577	T-8	4	350			
	-38-100C	100	133		-	-	23	16	M2577	T-8	4	370								
	-38-130C	130	163		-	-	16						16	M2577	T-8	4	470			

BASE HOLDER for MODULAR TYPE (BT Shank)



Q

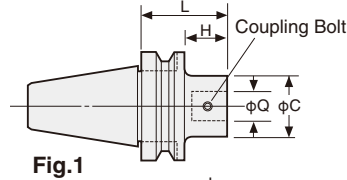

Fig.1

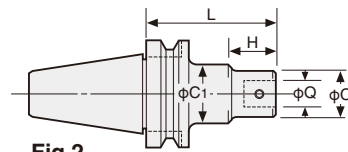

Fig.2

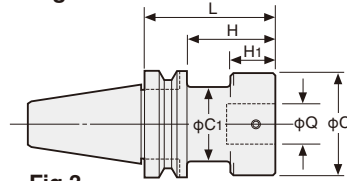

Fig.3

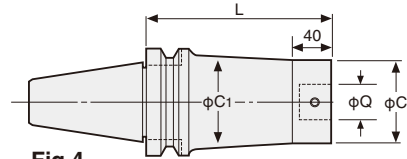

Fig.4

TAPER	Code No.	Coupling Dia Q	L	C	C1	H	H1	Coupling Bolt No.	Fig.	Weight (kg)	
No.30	BT30-Q 9- 50	9	50	19	30	20	-	B19	2	0.5	
	-Q12- 65	12	65	24	-	40		B12	1	0.5	
	-Q16- 50	16	50	31		25		B16		0.5	
	-Q20- 50	20	50	40		26		B20		0.5	
	-Q26- 40	26	40	50		45		18		6	B26N
No.40	BT40-Q 9- 80	9	80	19	30	5	-	B19	2	1.2	
	- 95N		95			27				1.2	
	-Q12- 80	12	80	24	35	12		B12		1.2	
	- 110		110			50					1.3
	-Q16- 95	16	95	31	42	22		B16		1.5	
	- 125		125			55					1.6
	-Q20- 80	20	80	40	50	27		B20	1.5		
	- 110		110			60				1.7	
	-Q26- 50	26	50	50	-	20		B26N	1	1.1	
	- 95		95			65				1.8	
	- 140		140			110				2.4	
	-Q34- 95	34	95	64	62	68		55	B34	3	2.2
	- 110		110			83					70
	-Q42- 95	42	95	83	-	68		55	B42	3	2.8
	No.50	BT50-Q 9- 110	9	110	19	40		5	-	B19	2
- 125N		125		27			4.1				
-Q12- 95		12	95	24	44	12	B12	4.0			
- 125			125			50				4.0	
-Q16- 125N		16	125	31	50	22	B16	4.5			
- 155			155			55				4.6	
-Q20- 110		20	110	40	60	27	B20	4.6			
- 125			125			60				4.5	
-Q26- 65		26	65	50	65	27	-	B26N		1	3.7
- 140			140			47				2	5.3
- 170N			170			112				2	5.4
-Q34- 140		34	140	64	80	102	-	B34		1	5.6
- 170			170			120				2	6.5
- 200			200			150				2	7.1
-Q42- 125		42	125	83	-	87	-	B42		1	6.5
- 190			190			152					9.1
-Q42- 225A		42	225	83	98	-	-	B42		4	12.9
- 275A			275								15.6
- 325A	325		18.3								
- 375A	375		21.0								

★All base holders have a centre through-tool coolant hole.

★The Coupling screw & wrench are supplied as standard.

★When L length is required longer than standard, please specify the boring depth M.

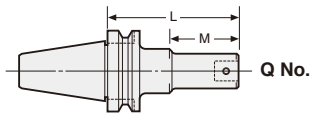

Q No.

SPACER for MODULAR TYPE



Extension Spacer

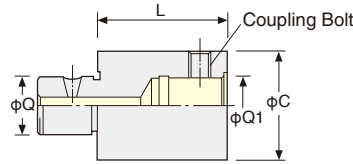

SP

Example of small diameter boring in a deep recess using the largest diameter extension spacer in order to maintain rigidity.

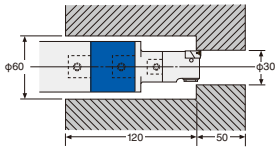

BT40-Q26-95
SP26-26-60
 SP26-12-30
 12-ZMAC25-40V

Example of deep hole boring using the extension spacer with the same diameter as head.

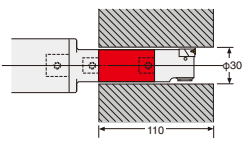

BT40-Q26-95
 SP26-12-30
SP12-12-60
 12-ZMAC25-40V

Code No. Q-Q1-L	Coupling Dia		C	Coupling Bolt No.	Weight (kg)
	Q	Q1			
SP 9- 9-30, 45	9	9	19	B19	0.06, 0.1
SP 12-12-30, 45, 60	12	12	24	B12	0.1, 0.15, 0.2
SP 16-16-30, 45, 60	16	16	31	B16	0.15, 0.25, 0.35
SP 20-20-45, 60	20	20	40	B20	0.4, 0.5
SP 26-26-60, 90	26	26	50	B26N	0.8, 1.2
SP 34-34-60, 90	34	34	64	B34	1.4, 2.0
SP 42-42-60, 90	42	42	83	B42	2.4, 3.4

★All spacers have a centre through-tool coolant hole.

★The Coupling screw is included as standard.

Stepped Spacer

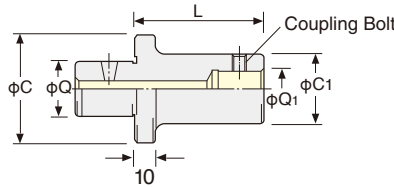

SP

Example of small diameter boring in deep recess using stepped spacer with the same diameter as head.

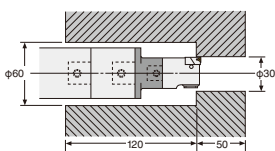

BT40-Q26-95
 SP26-26-60
SP26-12-30
 12-ZMAC25-40V

Code No. Q-Q1-L	Coupling Dia		C	C1	Coupling Bolt No.	Weight (kg)
	Q	Q1				
SP 12- 9-45	12	9	24	19	B19	0.1
SP 16- 9-45	16	9	31	19	B19	0.15
-12-60		12		24	B12	0.25
SP 20- 9-45	20	9	40	19	B19	0.2
-12-60		12		24	B12	0.3
-16-60, 90		16		31	B16	0.4, 0.6
SP 26- 9-30, 45	26	9	50	19	B19	0.3, 0.3
-12-30, 60		12		24	B12	0.3, 0.4
-16-30, 60, 90		16		31	B16	0.3, 0.5, 0.6
-20-30, 60, 100		20		40	B20	0.4, 0.6, 1.0
SP 34-16-60, 90	34	16	64	31	B16	0.7, 0.9
-20-60, 100		20		40	B20	1.0, 1.3
-26-60, 100		26		50	B26N	1.1, 1.5
SP 42-20-60, 100	42	20	83	40	B20	1.2, 1.6
-26-60, 100		26		50	B26N	1.4, 1.9
-34-60, 100		34		64	B34	1.8, 2.5

★All spacers have a centre through-tool coolant hole.

★Coupling bolt is supplied as standard.

A1 Spacer for Deep Hole



L/D:MAX.6 times

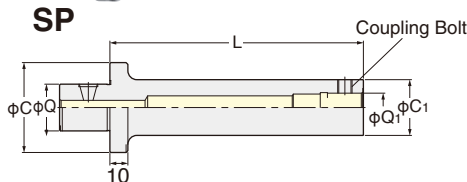

SP

Code No. Q-Q1-L	Coupling Dia		C	C1	MAX. L	Weight (kg)
	Q	Q1				
SP 26- 9- 85-A1	26	9	50	19	85	0.6
-12-115-A1		12		24	115	0.7
-16-140-A1		16		31	140	0.9
-20-180-A1		20		40	180	1.2
-26-190-A1		26		50	190	1.5

Please specify the "L" length when ordering. Code No. is e.g SP26-9-85-A1 (Q1=9 and L-85)



Modular connection system is the face contact system drawing-in by the bolt, which top shape is gentle taper.

1. Insert a head by adjusting the hole positions.
2. Tighten the bolt temporary, then loosen slightly.
3. Tighten the bolt again by moving the head CW and CCW. (Centering each other)
4. Then tighten the bolt completely until face contact.

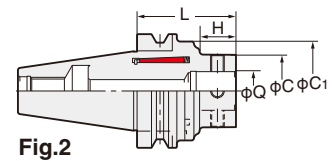
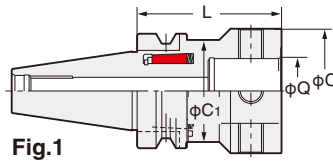

MDQ

Photo shows with A1 spacer and ZMACα-V head.

TAPER	Code No.	Q	L	C	C1	H	Weight (kg)	ZMAC-V Boring Range	Fig
No.30	NBT30-MDQ26- 60	26	60	50	50	37.5	-	16~70	1
No.40	NBT40-MDQ26- 65	26	65	50	54	30.0	1.3	16~70	2
No.50	NBT50-MDQ26- 80	26	80	50	87	22.0	4.6	16~70	2
	-MDQ34- 90	34	90	64	87	32.0	4.9	16~85	
	-MDQ42-100	42	100	83	87	45.0	5.7	16~180	

- ★All base holders are used for centre through tool coolant.
- ★Coupling bolt and wrench are supplied as standard.
- ★ZMACα-V head is recommended to use with the MAJOR DREAM base holder for anti-vibration.
- ★When L length is required longer than standard, please specify the boring depth M and Q No.

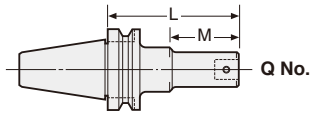

MODULAR TYPE STRAIGHT SHANK

K-Q

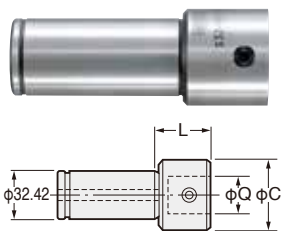

Code No.	Coupling Dia.	C	L	Coupling Bolt.	Weight (Kg)
	Q				
K32-Q 9-20	9	19	20	B19	0.4
-40			40		0.5
-Q12-20	12	24	20	B12	0.4
-60			60		0.6
-Q16-20	16	31	20	B16	0.5
-55			55		0.7
-Q20-40	20	40	40	B20	0.7
-Q26-40	26	50		B26N	0.8
K42-Q26-40				B26N	1.2

★All straight shank base holders are used for centre through tool coolant.

CHANFERING CUTTER for Modular System

CAF

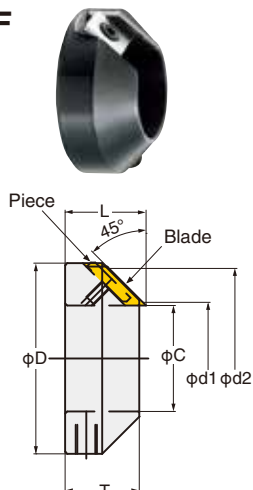

Code No.	Coupling Dia.	C	D	T	L	Chamfering Dia. d1~d2	Blade	Piece
CAF 9- 32	9	19	35	20	21.9	20~32	CB-2	CR-2
CAF12- 38	12	24	42			25~38		
CAF16- 45	16	31	49			33~45		
CAF20- 60	20	40	64	25	27.2	42~60	CB-5	CR-5
CAF26- 85A	26	50	90	35	38.2	56~85	CB-6	CR-6
CAF34-110	34	64	115			40.2		

- ★Chamfering angle is 45°
- ★Material of Blade : Cermet(T12A)

MODULAR TYPE BORING HEAD

NIKKEN

BCB Micro-Cut Boring Head

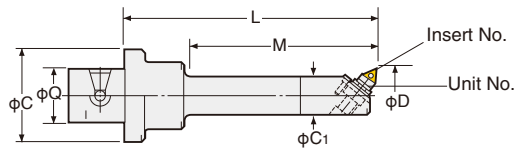

Code No.	Boring Range D	Boring Depth M	Coupling Dia Q	Total Length L	C	C ₁	Unit No.	Insert No.
Q26-BCB12.7S- 95	12.7~14.5	60	26	95	50	12	M1-12.7	1MP-T
Q26-BCB14.5S-100	14.5~19.5	65		100		13	M1-14.5	
Q26-BCB19 S-125	19 ~22.5	90		125		18	M2-19	

★“T” grade (Cermet) insert is supplied as standard. P.88 Please refer P.86 for cutting condition.

★Min. dial readout (on dia) : 0.02mm (Sub scale : 0.004mm)

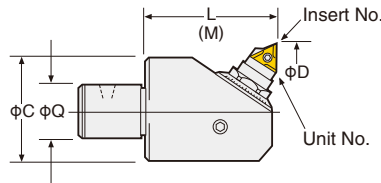

Set/Head Code No	Boring Range D	Boring Depth M	Coupling Dia Q	Remarks		
				C	Unit No.	Insert No.
9-BCB 22 - 40	22 ~29.5	40	9	20	M 2- 22	3MS-T
12-BCB 29 - 40	29 ~ 41		12	25	M 3- 29	
16-BCB 38 - 55	38 ~ 50	55	16	35	M 5- 38	6MP-C
20-BCB 48 - 70	48 ~ 65	70	20	41	M 5- 48	
26-BCB 62 - 70	62 ~ 90		26	54	M 7- 62	10MP-T
34-BCB 82 - 85	82 ~ 110	34	67			
42-BCB100 -100	100~ 140	100	42	85	M10-100	

★“6MP-C” (Coaterd) insert or “T” grade (Cermet) insert is supplied as standard. P.88 Please refer P.86 for cutting condition.

★Min. dial readout (on dia) : 0.02mm (Sub scale : 0.002mm)

★Code No. of the set with SP26 stepped spacer is Q26-Coupling Dia.-BCB○-Length e.g. Q26-20-BCB48-100

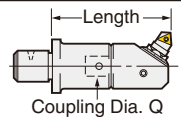

Straight Shank MICRO CUT BORING BAR

NIKKEN

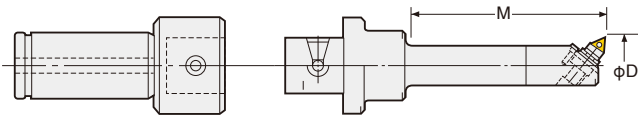

The sales of micro cut boring bar will be finished, when the stock is sold out.



K-BCB

Style	Code. No.	Q Holder Code. No.	Head No.	Boring Range φD	Boring Depth M	Insert No.
K32	K32-BCB12.7S-135	K32-Q26-40	Q26-BCB12.7S- 95	12.7~14.5	60	1MP-T
	-BCB14.5S-140		-BCB14.5S-100	14.5~19.5	65	

★Please refer P.39 for straight shank base holder and P.40 for micro cut head.

★“T” grade (Cermet) Insert is supplied as standard. P.88 Please refer P.86 for cutting condition.

★Please use ZMAC-V Boring Bar for the bore dia. is larger equal to φ16mm. P.41

★Min. dial readout (on dia) : 0.02mm (Sub scale : 0.004mm)

Straight Shank BALANCE CUT BORING BAR

NIKKEN

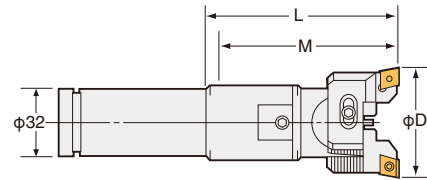
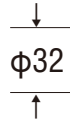

K-RAC

You can use following boring tools with C32 Milling Chuck. It is convenient for Various/Small Volume Productions. Use with Straight Shank ZMAC-V Boring Bar.

P.12

Code No.	Boring Range D	Boring Depth M	Shank Code No.	Head No.	Insert No.	Weight (kg)
K32-RAC25- 75E	25~ 32	70	K32-Q12-20	12-RAC 25- 55E	CC07-C	0.8
-115E		93	-Q12-60			0.9
-RAC32- 75E	32~ 45	70	-Q16-20	16-RAC 32- 55E	CC08-C	1.1
-110E			-Q16-55			1.3
-RAC43-110E	43~ 55	105	-Q20-40	20-RAC 43- 70E	CC12-C	1.7
-RAC53-110E	53~ 70		-Q26-40	26-RAC 53- 70E		1.8
-RAC70-110E *	70~ 100			26-RAC 70- 70E		1.9

★Balance cut boring bar on above table is the boring bar with the cartridges (E) for steel, stainless and cast iron.

“C” grade (Coated) insert tip is supplied as standard. **P.12**

★Boring bar with the cartridges for heavy duty boring of iron and cast iron **P.15**, for aluminium (A) **P.17** and for through hole and multi sheets (K) **P.19**
Please refer **P.85** for cutting condition.

★Shank (P.37) and head (P.19) are delivered in separate packages.

★For centre through tool coolant type except **K32-RAC70-110E** marked *, please add “-C” at the end of Code No. e.g. **K32-RAC53-110E-C**

Straight Shank ZMAC ADVANCED BORING BAR

NIKKEN

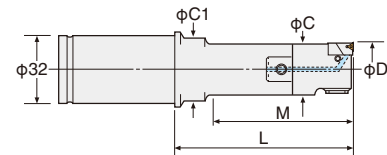

K-ZMAC-V

You can use following boring tools with C32 Milling Chuck. It is convenient for Various/Small Volume Productions.

Code No.	Boring Range D	Boring Depth M	C	C ₁	Shank Code No.	P.88		P.26		Weight (kg)
						Head No.	Insert No.	Head No.	Insert No.	
K32-ZMAC16- 65V	15.9~20.2	38	15	-	K32-Q12-20	12-ZMAC16-45V				0.5
- 75V		48				12-ZMAC16-55V				0.5
-ZMAC20- 60V	19.8~25.2	55	19	-	-Q 9-20	9-ZMAC20-40V	3MP-C,B			0.6
- 80V		63								30
-ZMAC25- 60V	24.8~32.2	55	24	-	-Q12-20	12-ZMAC25-40V				0.6
-100V		83								30
-ZMAC32- 75V	31.8~42.2	70	31	-	-Q16-20	16-ZMAC32-55V	4MP-C,B	16-ZMAC32R-55V	CC06-C	0.9
-110V										
-ZMAC42-110V	41.8~55.2	105	40	-	-Q20-40	20-ZMAC42-70V	6MP-C,B	20-ZMAC42R-70V		1.5
-ZMAC55-110V	54.8~70.2									53

★All Codes shown are for Heads with Triangular Inserts. **P.88**

P.26 For Heads with Rhomboid Inserts, please add “R” to the Code No. e.g.) **K32-ZMAC32 R -75V**

★MIN. dial read out: **ZMAC25-V** and smaller is 0.02mm on dia. **ZMAC32-V** and larger is 0.01mm on dia. (Sub scale : 0.005)

★“C” grade (coated) Insert for Steel, Stainless and Cast Iron is supplied as standard with the Head.

(Smooth Boring and Long tool-life) Please refer **P.86** for cutting condition.

We would recommend “B” grade (CBN) Insert for Hardened Steel and High Speed Boring of Cast Iron.

★Centre Through Tool Coolant function is available as standard.

Straight Shank DEEP HOLE ZMACX ADVANCED BORING BAR **NIKKEN**

Axially Adjustable and **Solid Carbide**



For Deep Hole Boring



For Deep Hole Boring with Extended Gauge Length

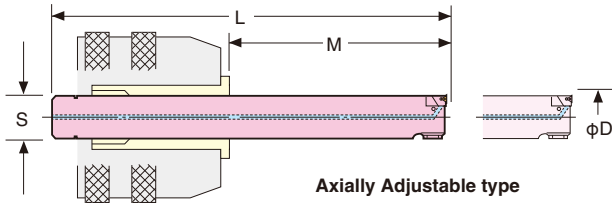

S-ZMACX-V

Code. No.	Boring Range D	Boring Depth M	L	S	Unit No.	Insert No.	Weight (kg)	Suitable Holder	
								Chuck	KM Collet
S12-BCBX12.7- 95	12.7~14.5	50~ 95	130	12	M1-12.7	1MP-T	0.2	BT40-C32 BT50-C32	KM32-12
S13-BCBX14.5-105	14.5~19.5	50~105	135	13	M1-14.5				-13
S15-ZMACX16-120V	15.9~20.2	65~120	150	15	M2HZ-16V	0.3	-15		
S19-ZMACX20-150V	19.8~25.2	100~150	180	19	M2HZ-20V		0.6		-19
S24-ZMACX25-190V	24.8~32.2	140~190	220	24	M3HZ-25V	1.3	-24		
S30-ZMACX32-260V	31.8~42.2	190~260	290	30	M4HZ-32V	4MP-C, B	2.6		-30
S32-ZMACX42-275V	41.8~55.2	205~275	305	32	M5HZ-42V		3.8	-	

★T grade (Cermet) insert tip or "C" grade (Coated) insert tip is supplied as standard for **BCBX** or **S-ZMACX-V** respectively.
 ☞ P.88 Please refer ☞ P.86 for cutting condition.

★Centre Through Tool Coolant function of **ZMACX-V** is available as standard. ★MIN. dial read out: **BCBX12.7,BCBX14.5** is 0.02mm (Sub scale : 0.004)

★MIN. dial read out: **ZMAC25-V** and smaller is 0.02mm on dia. **ZMAC32-V** and larger is 0.01mm on dia. (Sub scale : 0.005)

Deep Hole Boring Operation with combination of Milling Chuck, Collet and S-ZMACX-V Boring Bar.

Ultra Deep Hole Boring MAX.L/D=8 times with Carbide Solid Boring Bar

Axially Adjustable with Milling Chuck

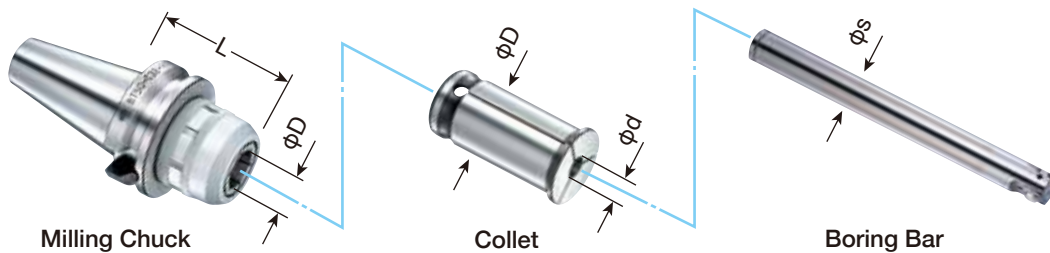

TAPER	Milling Chuck Code No.	Collet
No.40	BT40 -C20- 70, 90, 105, 120	KM20
	-C25- 70, 90, 120	KM25
	-C32- 85, 105, 120	KM32
No.50	BT50 -C20-105, 135, 165, 180	KM20
	-C25-105, 135, 165	KM25
	-C32- 90, 105, 120, 135, 165	KM32
	-C42- 95, 105, 120, 135, 165	KM42

KM Collet No.
KM20-12
-13
KM25-12
-13
-15
KM32-12
-13
-15
-19
-24
-30
-

Deep Hole Boring Bar Code No.
S12-BCBX12.7- 95
S13-BCBX14.5-105
S12-BCBX12.7- 95
S13-BCBX14.5-105
S15-ZMACX16-120V
S12-BCBX12.7- 95
S13-BCBX14.5-105
S15-ZMACX16-120V
S19-ZMACX20-150V
S24-ZMACX25-190V
S30-ZMACX32-260V
S32-ZMACX42-275V

★KM42-12, 13, 15, 19, 24, 30, 32 are also available.

Straight Shank DJ BORING BAR



K-DJ

You can use following boring tools with C32 Milling Chuck.
It is convenient for Various/Small Volume Productions.



Code No.	Boring Range D	Boring Depth M	L	C	Bit Hole Size L	Shank Code No.	Head No.	Bit Stroke S	Bit Code No.	Weight (kg)
K32-DJ3-80A	3~28	14~ 80	80	50	10	K32-Q26-40	Q26-DJ3-40A	5.2	J10	1.3
-DJ8-84AN	3~50	14~130	84	59	16		-DJ8-44AN	6.0	J16	1.6

- ★MIN. dial readout on dia.: 0.01mm, Sub scale: 0.005mm, 0.8mm/rev.
- ★Each box set of DJ3 and DJ8 Boring Bar includes 4 pcs of Boring Bits and insert tips.
Bits included to **K32-DJ8-84A** : J16-8-40, J16-18-80, J16-28-85, J16-38-85
Bits included to **K32-DJ8-84AN** ; J16-8-40, J16-18-60, J16-28-65, J16-38-65
- ★Please refer P.36 for Boring Bit. Please refer P.87 for cutting condition.
- ★DJ Boring Bar without Boring Bits is available. Please add "-BD" at the end of Code No. e.g. K32-DJ8-84A-BD

MULTI STAGE BORING BAR



Please provide your material drawing, machining drawing and machine information for multi stage boring bars.

Multi-Boring



Rough Boring by ISO Cartridge



Boring, Over Turning



Rough Boring by ISO Cartridge



Multi-Boring



Please supply ISO cartridges basically, even we can provide by ourselves.

BORING BAR for SQUARE & CYLINDRICAL BORING TOOL



BSA BSB BOA

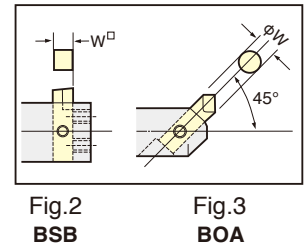
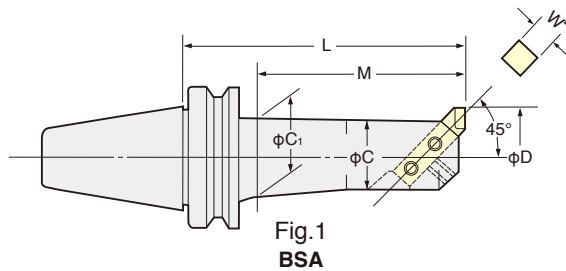

TAPER	Code No.		Boring Range	Boring Depth	Dimension				Fig
	BTNo.-Min D	-L			D	M	W	C	
No.40	BT40-BSA	25-135	25~38	108	8	20	22	1.3	Fig.1
	(IT40)-BSA	30-165	30~42	138		24	26	1.5	
	-BSA	38-180	38~52	153	10	30	33	1.8	
	-BSA	42-210	42~56	183		34	37	2.3	
	-BSA	50-180,225	50~65	153, 198	13	40	44	2.4, 2.9	
	-BSA	62-180,240	62~90	153, 218	16	50	56	3.2, 4.2	
	-BSA	72-180,240	72~110	153, 213	19	60	63	4.4, 5.7	
	-BSA	90-180	90~125	180		75		5.4	
No.50	BT50-BSA	25-135	25~38	95	8	20	22	4.4	BSA
	(IT50)-BSA	30-165	30~42	125		24	26	4.6	
	-BSA	38-180	38~52	140	10	30	33	4.8	
	-BSA	42-210	42~56	170		34	37	5.0	
	-BSA	50-180,240	50~65	140, 200	13	40	44	5.4, 5.7	
	-BSA	62-195,270	62~90	155, 230	16	50	56	6.1, 7.5	
	-BSA	72-195,285	72~110	155, 245	19	60	66	6.9, 9.3	
	-BSA	90-210,300	90~125	170, 260		75	80	9.2,12.3	
No.40	BT40-BSB	25-135	25~50	108	8	20	22	1.3	Fig.2
	(IT40)-BSB	38-180	38~70	153	10	30	33	1.9	
	-BSB	50-180,225	50~90	153, 198	13	40	44	2.6, 3.1	
	-BSB	62-180,225	62~115	153, 198	16	50	56	3.4, 4.1	
	-BSB	72-180,225	72~138	153, 198	19	60	63	4.7, 5.6	
	-BSB	90-180,225	90~150	180, 225		75		5.7, 6.6	
No.50	BT50-BSB	25-135	25~50	95	8	20	22	4.1	BSB
	(IT50)-BSB	38-180	38~70	140	10	30	32	4.8	
	-BSB	50-180,240	50~90	140, 200	13	40	44	5.5, 5.7	
	-BSB	62-195,270	62~115	155, 230	16	50	56	6.4, 7.9	
	-BSB	72-195,285	72~138	155, 245	19	60	66	7.3, 9.6	
	-BSB	90-210,300	90~150	170, 260		75	80	9.6,12.6	
	-BSB105-195,285	105~190	155, 245	25	90	94	11.0,15.0		
No.40	BT40-BOA	25-135	25~31	107	8	20	22	1.3	Fig.3
	(IT40)-BOA	30-165	30~35	137		24	26	1.5	
	-BOA	34-165	34~42	137	10	28	30	1.7	
	-BOA	40-180	40~46	152		32	35	2.3	
	-BOA	44-210	44~54	182	12	36	39	2.4	
	-BOA	52-180,225	52~60	152, 197		42	46	2.5, 3.0	
No.50	BT50-BOA	25-135	25~31	97	8	20	22	4.2	BOA
	(IT50)-BOA	30-165	30~35	127		24	26	4.4	
	-BOA	34-180	34~42	142	10	28	30	4.7	
	-BOA	40-210	40~46	172		32	35	5.0	
	-BOA	44-210	44~54	172	12	36	39	5.1	
	-BOA	52-180,240	52~60	142, 202		42	46	5.1, 6.0	

★Square or Cylindrical Boring Bit is not included.

★When L length is required longer than standard, please specify the boring depth M.

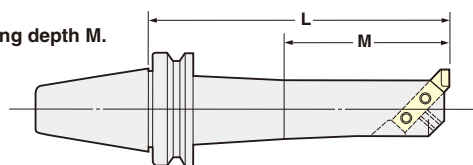

BT

3LOCK (triple contact) can be done on the BT double face contact spindle.

1. Power of Dampening Effect.

Tool Life
3 to 5 times

High Speed

Performance enhancement due to the dampening effect are already universally recognized when using Nikken's DREAM-CUT Holder.
- Extended tool life of 3 to 5 times.

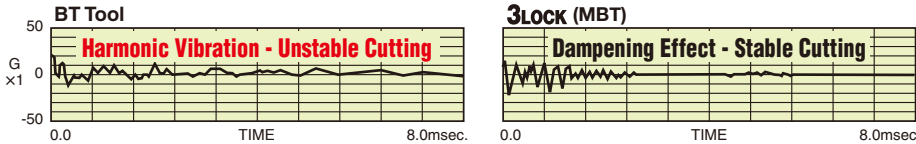

2. The mechanism which generates the excellent cutting performance -Internal Expanding Pressure System

1. When **3LOCK** tool is inserted into **3LOCK** spindle (before clamping) , the gap between the spindle flange and the tool flange is ; #40 : 0.2mm, #50 : 0.5mm
2. When the tool is clamped, the taper cone pre-loaded by the disc springs deforms radially and slides to reach the face contact between the spindle flange and the tool flange.

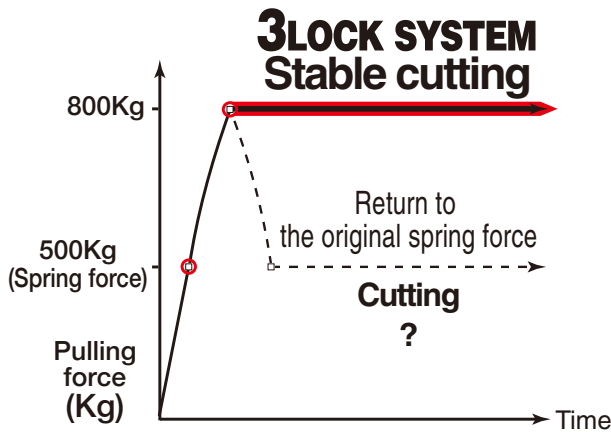
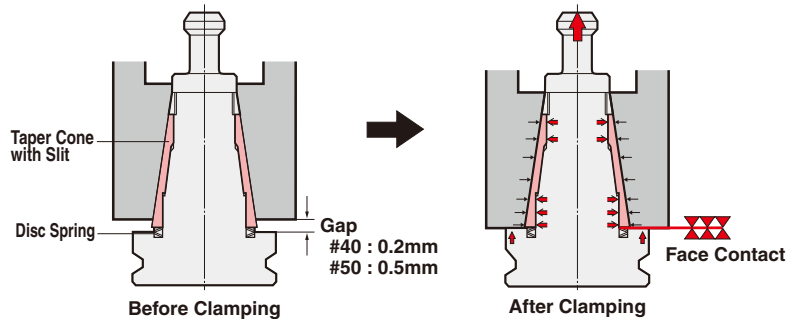

Internal Expanding Mechanism System for instantly locking the maximum pulling force

- Tool clamping mechanism that use a disc springs experience lower clamping force during continuous use.
- **3LOCK** is a system for locking the maximum pulling force that is instantly produced during tool pulling.
- Cutting torque is greatly reduced compared to BT tooling for more comfortable cutting.

Machine spindle expansion due to the centrifugal force at the high speed rotation or heat expansion

3. The taper sleeve follows the expansion and maintains perfect contact with the taper and flange.

Taper Contact : Flange Contact = 90% : 10%

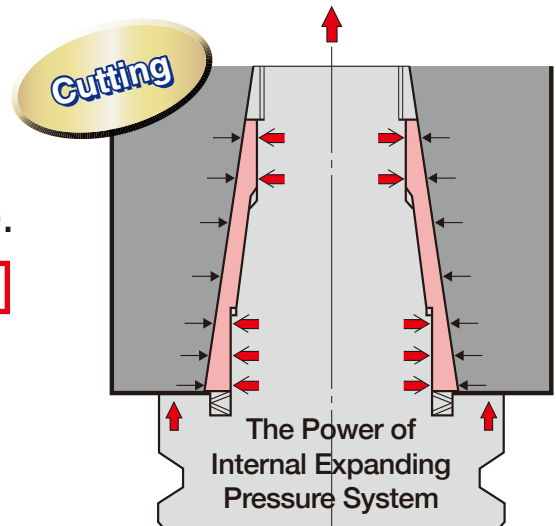

3LOCK TECHNICAL INFORMATION



Deep Hole Boring

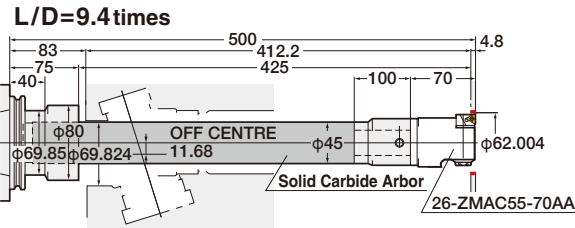
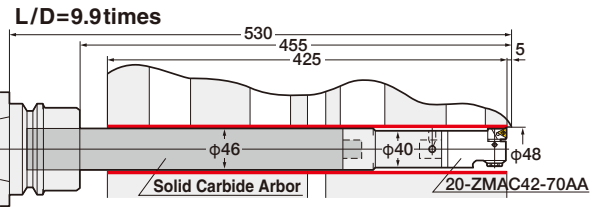
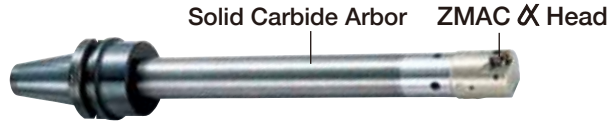

Material: Aluminum
Stock Removal: 0.23~0.27mm/dia.

V : 450m/min.
S : 3,000min⁻¹
F : 180mm/min.

Material: Aluminum
Stock Removal: 0.5mm/dia.

V : 545m/min.
S : 3,000min⁻¹
F : 210mm/min.

Deep Profiling Tool for Die Mould
Strong track record even for plunge cutting cutters with a long expanded length



3LOCK

2LOCK

BT DOUBLE FACE CONTACT SPINDLE



The NIKKEN **3LOCK** tooling can be used as the triple face contact (taper, flange and internal taper expansion) on the M/C with BT double face contact spindle. The NIKKEN **2LOCK** tooling can be used as the double face contact on the M/C with BT double face contact spindle.

#30

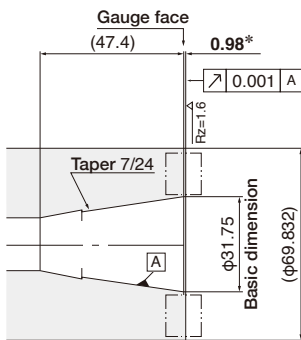

#40

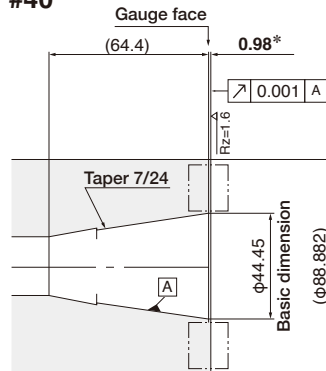

#50

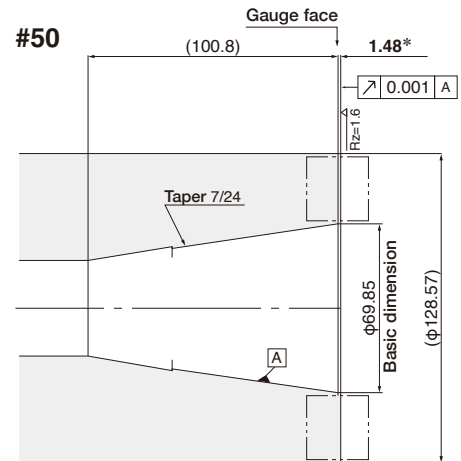

* mark: The tolerances of the extension of the spindle flange from gauge face depend on the M/C.

2LOCK TOOLING SYSTEM



2LOCK tool(NBT)is created from the technology of the **3LOCK** tool(MBT)with its acclaimed cutting and safe and reliable triple contact type. A series of MAJOR DREAM Holders and high speed tooling were created using the **2LOCK** tool system.

- MIN. Z-axis displacement at high speed rotation
- Improved run-out accuracy of ATC repeatability

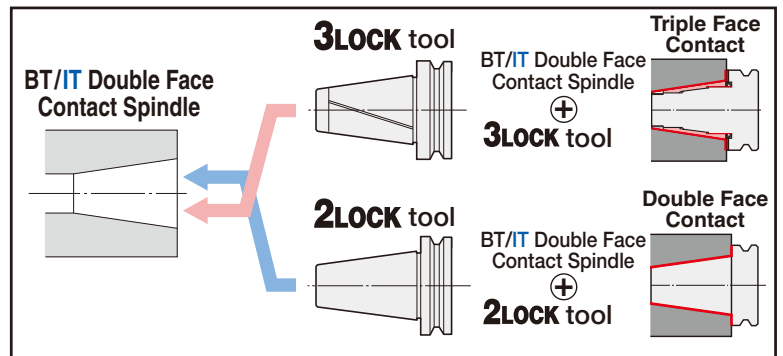

2LOCK tool can also be used on the machine with BT/IT standard spindle.

The Nikken **2LOCK** tooling system is not a simple taper/flange double face contact tool. The built-in dampening mechanism and front chucking mechanism have a variety of features.

3LOCK ZMAC ADVANCED BORING ARBOR (ZMAC-V)



3LOCK

Boring for Finishing



ZMAC-V
Photo shows ZMAC α -V.

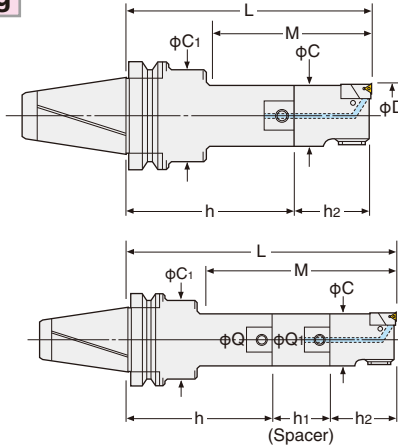

No Micro Vibration due to Double-Contact Support of Cartridge. Long Tool-Life & High Accuracy.

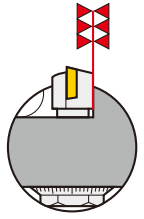

Only for ZMAC16-V

All codes shown are for heads with triangular inserts For heads with rhomboid inserts please add the letter "R" to the code No. e.g. MBT40-ZMAC32 R -150V

TAPER	Code No. MBTNo.- Min.D - L	Boring Range D	Boring Depth M	Cupling Dia M	C	C1	P.88		Weight (kg)
							Head No. Q- Min.D -h2	Insert No.	
No.40	MBT40-ZMAC 16-125V, 135V	15.9~20.2	38, 48	12	15	24	12-ZMAC16-45V, 55V		1.9, 1.9
	(MIT40)-ZMAC 20-120V, 135V, 150V	19.8~25.2	45, 67, 75	9	19	30	9-ZMAC20-40V	3MP-C,B	1.9, 1.9, 2.0
	-ZMAC 25-120V, 150V, 165V	24.8~32.2	52, 90, 97	12	24	35	12-ZMAC25-40V		2.0, 2.1, 2.1
	-ZMAC 32-150V, 180V, 195V	31.8~42.2	77, 110, 122	16	31	42	16-ZMAC32-55V	4MP-C,B	2.5, 2.7, 2.7
	-ZMAC 42-150V, 180V, 210V	41.8~55.2	97, 130, 157	20	40	50	20-ZMAC42-70V	6MP-C,B	3.0, 3.2, 3.5
	-ZMAC 55-165V, 210V, 225V	54.8~70.2	135, 180, 195	26	53	50	26-ZMAC55-70V		3.9, 4.6, 4.6
	-ZMAC 70-165V, 180V, 225V	69.8~85.2	165, 180, 225	34	67	64	34-ZMAC70-70V		5.4, 5.8, 6.8
-ZMAC 85-195V	84.8~100.2	195	42	83	62	42-ZMAC85-100V	9.0		
No.50	MBT50-ZMAC 16-140V, 150V	15.9~20.2	38, 48	12	15	24	12-ZMAC16-45, 55V		4.7, 4.7
	(MIT50)-ZMAC 20-150V, 165V, 180V	19.8~25.2	45, 67, 75	9	19	40	9-ZMAC20-40V	3MP-C,B	4.8, 4.8, 4.9
	-ZMAC 25-135V, 165V, 180V	24.8~32.2	52, 90, 97	12	24	44	12-ZMAC25-40V		4.8, 4.8, 4.9
	-ZMAC 32-180V, 210V, 225V	31.8~42.2	77, 110, 122	16	31	50	16-ZMAC32-55V	4MP-C,B	5.5, 5.6, 5.7
	-ZMAC 42-180V, 195V, 225V, 240V	41.8~55.2	97, 130, 142, 157	20	40	60	20-ZMAC42-70V	6MP-C,B	6.0, 6.0, 6.4, 6.5
	-ZMAC 55-210V, 240V, 270V	54.8~70.2	117, 182, 177	26	53	65	26-ZMAC55-70V		7.5, 7.6, 8.1
	-ZMAC 70-240V, 270V, 300V	69.8~85.2	190, 220, 250	34	67	80	34-ZMAC70-70V		10.0, 10.6, 11.5
	-ZMAC 85-225V, 290V, 315V	84.8~100.2	182, 247, 272				42-ZMAC85-100V		12.5, 15.0, 16.0
	-ZMAC100-225V, 290V*	99.5~140.5	225, 290	42	83	83	42-ZMAC100-100V	13.8, 16.5	
	-ZMAC140-225V, 290V*	139.5~180.5					42-ZMAC140-100V	14.6, 17.3	

- ★MIN. dial readout : ZMAC25-V & smaller is 0.02mm on diameter. ZMAC32-V and larger are 0.01mm on diameter. (Sub scale : 0.005)
- ★"C" grade (Coated) insert for Steel, Stainless & Cast Iron is supplied as Standard with the head (Smooth boring & Long tool-life). We would recommend "B" grade (CBN) insert for Hardened Steel & High Speed boring of Cast Iron. Please refer P.86 for cutting condition.
- ★Please refer P.49 for Shank, and P.38 for Spacer, and P.27 for Head.
- ★Centre Through Tool Coolant function is available as standard.
- ★When L length is required longer than standard, please specify boring depth M.
- ★* : MBT50-ZMAC100-325V, 375V, 425V, 475V are also available.
MBT50-ZMAC140-325V, 375V, 425V, 475V

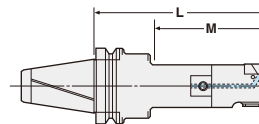

High Pressure Coolant Through Tool

High Speed Boring ZMAC α -V
Special Hardened Light Alloy Metal Head with Balancing for Anti-Vibration.
MAX12,000min⁻¹

ZMAC-V for Multi-Stage Boring Bar
P.34, P43

Please contact us for the special boring bar.

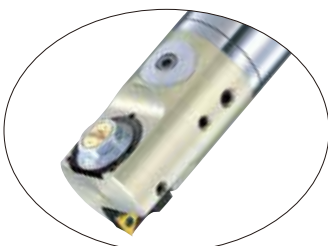

Photo. shows NC5 shank.

Please add "AA" at the end of Code No. for the boring arbor with ZMAC α -V head. P.28
e.g. MBT40-ZMAC42-150AAV

3BLOCK BALANCE-CUT BORING ARBOR

NIKKEN



Boring for Roughing

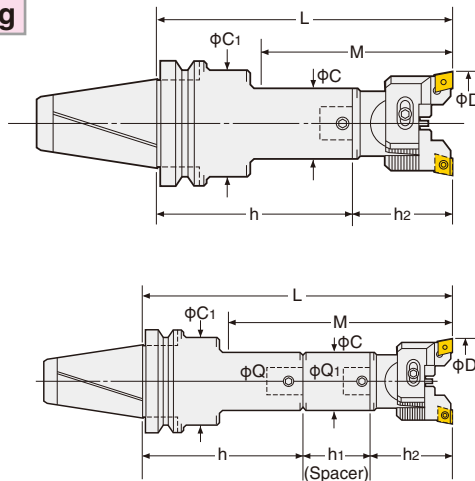

Power of Shoulder Support

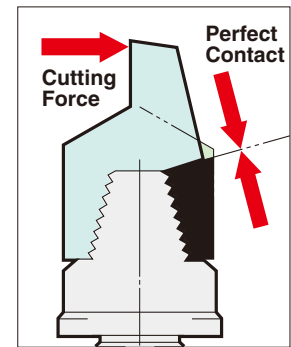

3Block

TAPER	Code No.	Boring Range D	Boring Depth M	Coupling Dia Q	C	C1	P.12		Weight (kg)
							Head No.	Insert No.	
	MBTNo.- Min.D -L						Q- Min.D -h2		
No.40	MBT40-RAC 25-135E, 165E, 180E	25~32	67, 105, 112	12	24	35	12-RAC 25- 55E	CC07-C	2.0, 2.1, 2.1
	(MIT40)-RAC 32-150E, 180E, 195E	32~45	77, 110, 122	16	31	42	16-RAC 32- 55E	CC08-C	2.4, 2.6, 2.6
	-RAC 43-150E, 180E, 210E	43~55	97, 130, 157	20	40	50	20-RAC 43- 70E	CC12-C	2.7, 2.9, 3.2
	-RAC 53-165E, 210E, 225E	53~70	135, 180, 195	26	50	50	26-RAC 53- 70E		2.5, 3.3, 3.2
	-RAC 70-180E, 195E, 240E	70~100	180, 195, 240	34	64	64	34-RAC 70- 85E		4.8, 5.2, 6.2
	-RAC100-195E	100~130	195	42	83	62	42-RAC100-100E		6.8
No.50	MBT50-RAC 25-150E, 180E, 195E	25~32	67, 105, 112	12	24	44	12-RAC 25- 55E	CC07-C	4.7, 4.9, 4.8
	(MIT50)-RAC 32-180E, 210E, 225E	32~45	77, 110, 122	16	31	50	16-RAC 32- 55E	CC08-C	5.4, 5.6, 5.6
	-RAC 43-180E, 195E, 225E, 240E	43~55	97, 130, 142, 157	20	40	60	20-RAC 43- 70E	CC12-C	5.7, 5.8, 6.1, 6.2
	-RAC 53-210E, 240E, 270E	53~70	117, 182, 177	26	50	65	26-RAC 53- 70E		6.9, 7.0, 7.6
	-RAC 70-255E, 285E, 315E	70~100	205, 235, 265	34	64	80	34-RAC 70- 85E		9.5, 9.9, 10.9
	-RAC100-225E, 290E, 325E *	100~130	225, 290, 325	42	83	83	42-RAC100-100E		12.5, 12.5, 16.5

★“C” grade (Coated) inserts are supplied as standard with the head. P.12 Please refer P.85 for cutting condition.

★Please refer P.49 for base holder, P.38 for spacer and P.19 for head.

★For centre through tool coolant type, please add “-C” at the end of Code No. e.g. MBT40-RAC53-165E-C

★Cartridges & Insert tips for the Heavy Duty Boring of Iron and Cast Iron (No letter), for Aluminum (A), and for Through Hole & Multiple Sheets (K) are available. Please refer P.20 for cartridges. Please add the letter “No letter”, “A” or “K” at the end of Code No. e.g. MBT40-RAC53-165A

★When L length is required longer than standard, please specify the boring depth M.

★Cartridge & Insert for Alloy Steel (E) is recommended for boring on steel and stainless steel.

★* : MBT50-RAC100-375E, 425E and 475E are also available.

Code No. of RAC25 and RAC32 with CC inserts are changed to RAC25E and RAC32E.

Please refer P.11, P.12

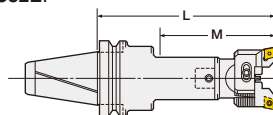

High Pressure Coolant Through Tool

3LOCK MODULAR TYPE BORING BASE HOLDER

NIKKEN

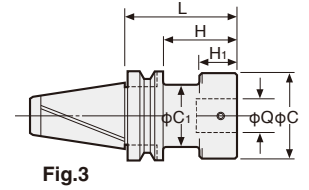
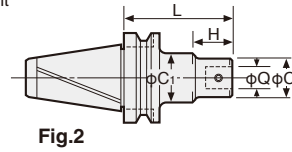
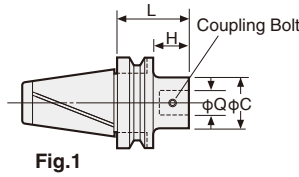

Q

3LOCK tooling (MBT) can be used as the triple contact tooling on the M/C where spindle is BT double face contact system.

TAPER	Code No.	Coupling ϕQ	L	C	C ₁	H	H ₁	Coupling Bolt No.	Fig.	Weight (kg)
No.40	MBT40-Q26- 50,95,140	26	50, 95,140	50	-	20,65,110	-	B26N	1	1.1, 1.7, 2.5
	(MIT40)-Q34- 95,110	34	95,110	64	62	68,83	55,70	B34	3	2.2, 2.6
	-Q42- 95	42	95	83	62	68	55	B42		2.8
No.50	MBT50-Q26- 65,140,170N	26	65,140,170	50	65	27,47,112	-	B26N	1,2,2	3.7, 5.3, 5.4
	(MIT50)-Q34-140,170,200	34	140,170,200	64	80	102,120,150	-	B34		5.6, 6.5, 7.1
	-Q42-125,190	42	125,190	83	-	87,152	-	B42	1	6.5, 9.1

- ★All base holders have a centre through-tool coolant hole.
- ★The Coupling screw & wrench are supplied as standard.
- ★When L length is required longer than standard, please specify the boring depth M.
- ★MBT50-Q42-225A, 275A, 325A and 375A are the arbor with tapered shape.

★Blank arbor with **3LOCK** shank is available.
MIN. order quantity of blank arbor is 5 off.

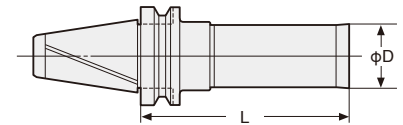
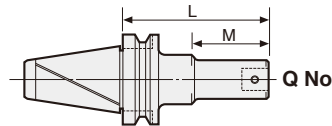

Please specify ;
· Hardness of arbor : Raw or HRC40±2
· $\phi D \times L$
e.g. $\phi D=50\text{mm}$, $L=200\text{mm}$ MBT50-BLK50-200

3LOCK DJ BORING HEAD with DJ BORING BIT

NIKKEN

High Pressure Coolant Through type is available Please contact with us.

Easy to Set **Micron Accuracy**



DJ

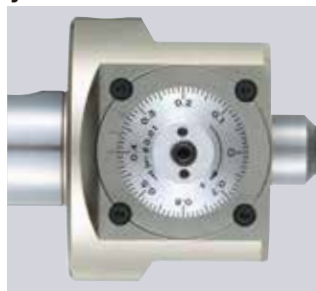

▲1Graduation:0.01mm on dia.

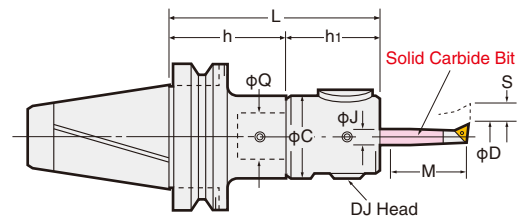

TAPER	Code No.	Boring Range	Boring Depth	L	C	Bit Hole Size	Shank Code No.	Head Code No.	Bit Stroke	Insert Tip Code No.
	MBTNo.-MinD-L	D	M			J	MBTNo.Q-h	Q-MinD-h ₁	S	
No.40	MBT40-DJ3- 90A	3~28	14~ 80	90	50	10	MBT40-Q26- 50	Q26-DJ3-40A	5.2	J10
	(MIT40) -135A			- 95						
	-DJ8- 94AN	3~50	14~130	94	59	16	MBT40-Q26- 50	-DJ8-44AN	6.0	J16
	-139AN			- 95						
No.50	MBT50-DJ3-105A	3~28	14~ 80	105	50	10	MBT50-Q26- 65	Q26-DJ3-40A	5.2	J10
	(MIT50) -210A			-170N						
	-DJ8-109AN	3~50	14~130	109	59	16	MBT50-Q26- 65	-DJ8-44AN	6.0	J16
	-214AN			-170N						

- ★MIN. dial readout on dia.: 0.01mm, Sub scale: 0.005mm, 0.8mm/rev.
- ★Each boxed set of DJ3 and DJ8 Boring Bars include 4 pcs of DJ Boring Bits as standard.
Bits included for MBT40-DJ8-94A : J16-8-40, J16-18-80, J16-28-85, J16-38-85
Bits included for MBT40-DJ8-94AN : J16-8-40, J16-18-60, J16-28-65, J16-38-65
- ★DJ Boring Bar without Boring Bits is also available. Please add “-BD” at the end of Code No. e.g. MBT40-DJ3-90A-BD
- ★Shank and DJ Head (including Boring Bits) are delivered in separate packages.
- ★Please refer P.36 for Boring Bits. Please refer P.87 for cutting condition.

3LOCK BALANCE-CUT BAC ADVANCED BORING ARBOR for LARGE DIA. NIKKEN



BAC-V

For Finishing

- Min. dial read out: main scale dia. 0.01mm, sub scale dia. 0.005mm
- Boring Dia: $\phi 130 \sim 595\text{mm}$

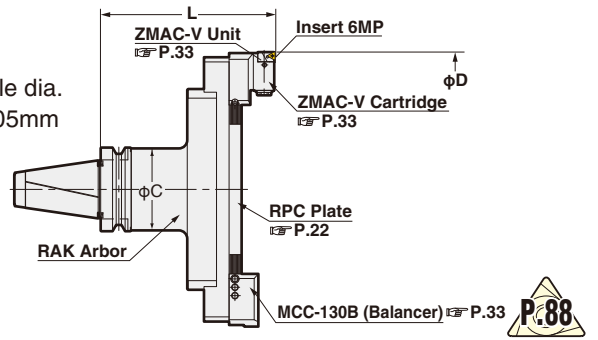

Boring Dia: $\phi 130 \sim 595\text{mm}$ for Finishing.

TAPER	Code.No	D		L	C	Arbor No.	RPC Plate No	Cartridge (Balancer)	Weight (kg)
		MIN.~MAX.							
No.40	MBT40 -BAC130-205V	130~195	205	61	MBT40-RAK-130A	RPC-130	MCCZ-130V (MCC-130B)	Insert Tip 6MP	6.8
	(MIT40) -BAC180-205V	180~245				-180			7.8
No.50	MBT50 -BAC130-185V, 235V, 285V	130~195	185, 235, 285	90	MBT50-RAK-110A, -160A, -210A	RPC-130	MCCZ-130V (MCC-130B)	Insert Tip 6MP	13.0, 14.5, 17.5
	(MIT50) -BAC180-185V, 235V, 285V	180~245				-180			13.5, 15.0, 18.0
	-BAC230-185V, 235V, 285V	230~295				-230			14.0, 15.5, 18.5
	-BAC280-185V, 235V, 285V	280~345	-280	14.5, 16.0, 19.0					
	-BAC330-210V*	330~395	210 (220*)	98	MBT50-RAK330-125 MIT50-RAK330-135	RPC-330			16.2
	-BAC380-210V*	380~445				-380			16.5
	-BAC430-210V*	430~495				-430			17.5
	-BAC480-210V*	480~545				-480			18.5
-BAC530-210V*	530~595	-530				19.5			

- ★“C” grade (Coated) Inserts are supplied as standard. Please refer P.86 for cutting condition.
- ★Unit “M5HZ-55V” is provided as standard, please refer P.22 for Arbor (RAK) and Plate (RPC).
- ★Arbor, Plate and Cartridge are delivered in separate packages.
- ★When ordering, please let us know machine maker and model no. to avoid the interference with tool magazine of ATC.
- ★The location of cutting edge is same as drive key in standard.
- The different location is available, please specify θ in Code No. e.g. MBT50-BAC180-235V-90°
- ★The boring arbors marked*with MIT50, L (gauge length) is 220. e.g. MIT50-BAC330-220V

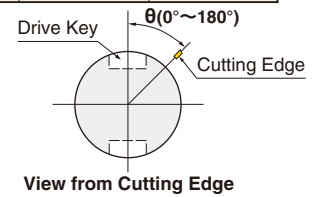

3LOCK BALANCE-CUT RAC BORING ARBOR for LARGE DIA. NIKKEN



RAC

For Roughing

- With slight adjust screw
- Boring Dia: $\phi 130 \sim 580\text{mm}$

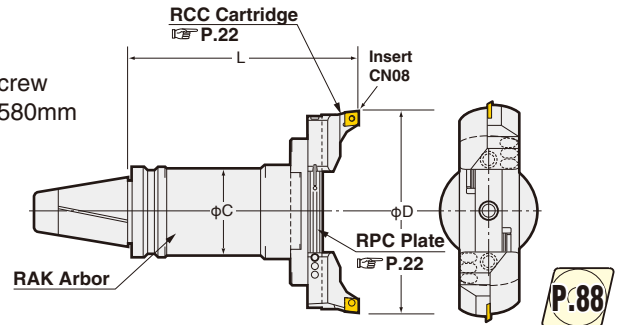

Boring Dia: $\phi 130 \sim 580\text{mm}$ for Roughing.

TAPER	Code.No	D		L	C	Arbor No.	RPC Plate No	Cartridge No. for Large dia.	Weight (kg)		
		MIN.~MAX.									
No.40	MBT40 -RAC130-205	130~180	205	61	MBT40-RAK-130A	RPC-130	MCCZ-130V (MCC-130B)	Insert Tip 6MP	6.8		
	(MIT40) -RAC180-205	180~230				-180			7.8		
No.50	MBT50 -RAC130-185, 235, 285	130~180	185, 235, 285	90	MBT50-RAK-110A, -160A, -210A	RPC-130	MCCZ-130V (MCC-130B)	Insert Tip 6MP	11.3, 12.8, 15.8		
	(MIT50) -RAC180-185, 235, 285	180~230				-180			11.8, 13.3, 16.3		
	-RAC230-185, 235, 285	230~280				-230			12.3, 13.8, 16.8		
	-RAC280-185, 235, 285	280~330	-280	12.8, 14.3, 17.3							
	-RAC330-210*	330~380	210 (220*)	98	MBT50-RAK330-125 MIT50-RAK330-135	RPC-330			MCCZ-130V (MCC-130B)	Insert Tip 6MP	15.5
	-RAC380-210*	380~430				-380					16.5
	-RAC430-210*	430~480				-430					17.5
	-RAC480-210*	480~530				-480					18.5
-RAC530-210*	530~580	-530				19.5					

- ★The Code No. on above table are the boring arbors with RCC-130 cartridge (Insert tip: CN08) the Heavy Duty Boring of Iron and Cast Iron. Please refer P.85 for cutting condition.
- ★Boring arbor with cartridges & insert for Steel, Stainless Steel and Cast Iron (E), for Aluminum (A) and for Through Hole & Multi Sheets (K) are available. Please refer P.22 for cartridges. e.g. MBT50-RAC130-185E
- ★Please refer P.22 for Arbor (RAK) and Plate (RPC).
- ★Arbor, Plate and Cartridge are delivered in separate packages.
- ★When ordering, please let us know machine maker and model no. to avoid the interference with tool magazine of ATC.
- ★The location of cutting edge is same as drive key in standard.
- The different location is available, please specify θ in Code No. e.g. MBT50-RAC180-235-90°
- ★The boring arbors marked *with MIT50, L (gauge length) is 220. e.g. MIT50-RAC330-220

3LOCK

2LOCK ZMAC ADVANCED BORING ARBOR (ZMAC-V) NIKKEN



Boring for Finishing

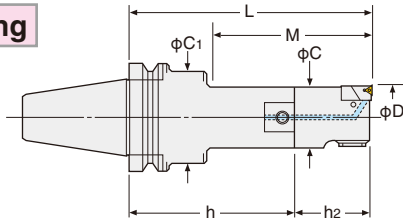

No Micro Vibration due to Double-Contact Support of Cartridge. Long Tool-Life & High Accuracy.

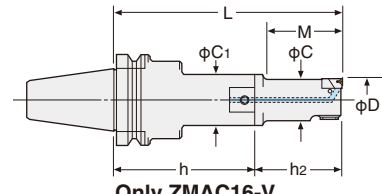
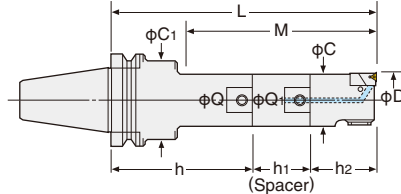
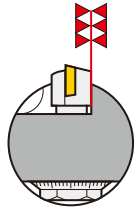

All codes shown are for heads with triangular inserts For heads with rhomboid inserts please add the letter "R" to the code No. e.g. NBT40-ZMAC32 R -150V

TAPER	Code No. NBTPNo.- Min.D - L	Boring Range D	Boring Depth M	Cupling Dia Q	C	C1	P.88		Weight (kg)
							Head No. Q- Min.D -h2	Insert No.	
No.40	NBT40-ZMAC 16-125V, 135V	15.9~20.2	38, 48	12	15	24	12-ZMAC16-45V, 55V	3MP-C,B	1.9, 1.9
	(NIT40)-ZMAC 20-120V, 135V, 150V	19.8~25.2	45, 67, 75	9	19	30	9-ZMAC20-40V		1.9, 1.9, 2.0
	-ZMAC 25-120V, 150V, 165V	24.8~32.2	52, 90, 97	12	24	35	12-ZMAC25-40V		2.0, 2.1, 2.1
	-ZMAC 32-150V, 180V, 195V	31.8~42.2	77, 110, 122	16	31	42	16-ZMAC32-55V	6MP-C,B	2.5, 2.7, 2.7
	-ZMAC 42-150V, 180V, 210V	41.8~55.2	97, 130, 157	20	40	50	20-ZMAC42-70V		3.0, 3.2, 3.5
	-ZMAC 55-165V, 210V, 225V	54.8~70.2	135, 180, 195	26	53		26-ZMAC55-70V		3.9, 4.6, 4.6
	-ZMAC 70-165V, 180V, 225V	69.8~85.2	165, 180, 225	34	67	64	34-ZMAC70-70V		5.4, 5.8, 6.8
	-ZMAC 85-195V	84.8~100.2	195	42	83	62	42-ZMAC85-100V		9.0
No.50	NBT50-ZMAC 16-140V, 150V	15.9~20.2	38, 48	12	15	24	12-ZMAC16-45V, 55V	3MP-C,B	4.7, 4.7
	(NIT50)-ZMAC 20-150V, 165V, 180V	19.8~25.2	45, 67, 75	9	19	40	9-ZMAC20-40V		4.8, 4.8, 4.9
	-ZMAC 25-135V, 165V, 180V	24.8~32.2	52, 90, 97	12	24	44	12-ZMAC25-40V		4.8, 4.8, 4.9
	-ZMAC 32-180V, 210V, 225V	31.8~42.2	77, 110, 122	16	31	50	16-ZMAC32-55V	6MP-C,B	5.5, 5.6, 5.7
	-ZMAC 42-180V, 195V, 225V, 240V	41.8~55.2	97, 130, 142, 157	20	40	60	20-ZMAC42-70V		6.0, 6.0, 6.4, 6.5
	-ZMAC 55-210V, 240V, 270V	54.8~70.2	117, 182, 177	26	53	65	26-ZMAC55-70V		7.5, 7.6, 8.1
	-ZMAC 70-240V, 270V, 300V	69.8~85.2	190, 220, 250	34	67	80	34-ZMAC70-70V		10.0, 10.6, 11.5
	-ZMAC 85-225V, 290V, 315V	84.8~100.2	182, 247, 272				42-ZMAC85-100V		12.5, 15.0, 16.0
	-ZMAC100-225V, 290V*	99.5~140.5	225, 290	42	83	83	42-ZMAC100-100V		13.8, 16.5
-ZMAC140-225V, 290V*	139.5~180.5					42-ZMAC140-100V	14.6, 17.3		

★MIN. dial readout : ZMAC25-V & smaller is 0.02mm on diameter. ZMAC32-V and larger are 0.01mm on diameter. (ZMAC25-V and larger : Sub scale : 0.005mm)
 ★"C" grade (Coated) insert for Steel, Stainless & Cast Iron is supplied as Standard with the head (Smooth boring & Long tool-life).

- ☞ P.88 Please refer ☞ P.86 for cutting condition.
- We would recommend "B" grade (CBN) insert for Hardened Steel & High Speed boring of Cast Iron.
- ★Please refer ☞ P.53, P.38 for Shank&Spacer, and ☞ P.27 for Head.
- ★Centre Through Tool Coolant function is available as standard.
- ★For NBT30, modular connection system is applied. Please refer ☞ P.53 for Base Holder.
- ★When L length is required longer than standard, please specify boring depth M.
- ★* : NBT50-ZMAC100-325V, 375V, 425V, 475V are also available.
 NBT50-ZMAC140-325V, 375V, 425V, 475V

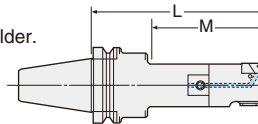

High Pressure Coolant Through Tool

High Speed Boring ZMAC X-V
 Special Hardened light alloy metal head with balancing for preventing from high frequency vibration.
 Ultra high speed boring: MAX.12,000min⁻¹

ZMAC-V for Multi-Stage Boring Bar
 ☞ P.34, P43

Please contact us for the special boring bar.



Photo. shows NC5 shank.

Please contact us for your application with the boring diameter. ☞ P.28
 e.g. NBT40-ZMAC42-150AAV
 Boring dia.:φ43.5mm



2LOCK BALANCE-CUT BORING ARBOR

NIKKEN

Boring for Roughing



RAC

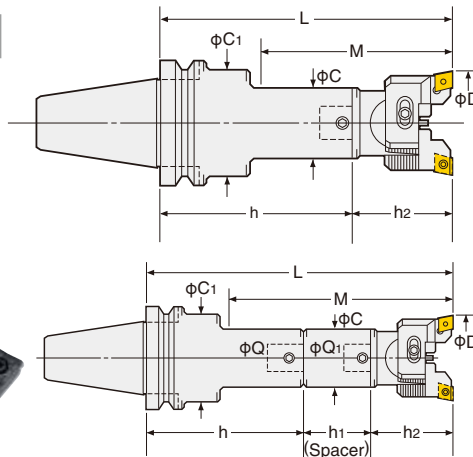

Power of Shoulder Support

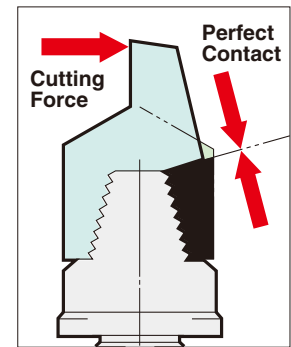

TAPER	Code No.	Boring Range D	Boring Depth M	Coupling Dia Q	C	C1	P.12		Weight (kg)
							Head No.	Tip No.	
	NBTNo.- Min.D -L						Q- Min.D -h2		
No.40	NBT40-RAC 25-135E, 165E, 180E	25~32	67, 105, 112	12	24	35	12-RAC 25- 55E	CC07-C	2.0, 2.1, 2.1
	(NIT40)-RAC 32-150E, 180E, 195E	32~45	77, 110, 122	16	31	42	16-RAC 32- 55E	CC08-C	2.4, 2.6, 2.6
	-RAC 43-150E, 180E, 210E	43~55	97, 130, 157	20	40	50	20-RAC 43- 70E	CC12-C	2.7, 2.9, 3.2
	-RAC 53-165E, 210E, 225E	53~70	135, 180, 195	26	50	62	26-RAC 53- 70E		2.5, 3.3, 3.2
	-RAC 70-180E, 195E, 240E	70~100	180, 195, 240	34	64	64	34-RAC 70- 85E		4.8, 5.2, 6.2
	-RAC100-195E	100~130	195	42	83	62	42-RAC100-100E		6.8
No.50	NBT50-RAC 25-150E, 180E, 195E	25~32	67, 105, 112	12	24	44	12-RAC 25- 55E	CC07-C	4.7, 4.9, 4.8
	(NIT50)-RAC 32-180E, 210E, 225E	32~45	77, 110, 122	16	31	50	16-RAC 32- 55E	CC08-C	5.4, 5.6, 5.6
	-RAC 43-180E, 195E, 225E, 240E	43~55	97, 130, 142, 157	20	40	60	20-RAC 43- 70E	CC12-C	5.7, 5.8, 6.1, 6.2
	-RAC 53-210E, 240E, 270E	53~70	117, 182, 177	26	50	65	26-RAC 53- 70E		6.9, 7.0, 7.6
	-RAC 70-255E, 285E, 315E	70~100	205, 235, 265	34	64	80	34-RAC 70- 85E		9.5, 9.9, 10.9
	-RAC100-225E, 290E, 325E*	100~130	225, 290, 325	42	83	83	42-RAC100-100E		12.5, 12.5, 16.5

- ★“C” grade (Coated) inserts are supplied as standard with the head. P.12 Please refer P.85 for cutting condition.
- ★Please refer P.53 for base holder, P.38 for spacer and P.19 for head.
- ★For centre through tool coolant type, please add “C” at the end of Code No. e.g. NBT40-RAC53-165-C
- ★Cartridges & Insert tips for the Heavy Duty Boring of Iron and Cast Iron (No letter), for Aluminum (A), and for Through Hole & Multiple Sheets (K) are available.
- Please refer P.20 for cartridges. Please add the letter “No letter”, “A” or “K” at the end of Code No. e.g. NBT40-RAC53-165A
- ★* : NBT50-RAC100-375E, 425E and 475E are also available.

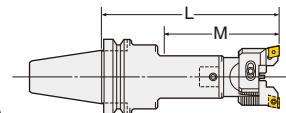

Code No. of RAC25 and RAC32 with CC inserts are changed to RAC25E and RAC32E. Please refer P.11, P.12

2LOCK MAJOR DREAM HOLDER BASE HOLDER for MODULAR TYPE

NIKKEN



MDQ

Photo shows with A1 spacer and ZMAC-V head.

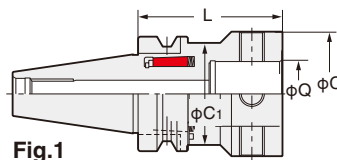

Fig.1

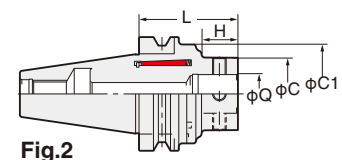
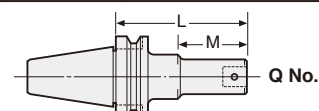

Fig.2

TAPER	Code No.	Q	L	C	C1	H	Weight (kg)	ZMAC-V Boring Range	Fig
No.30	NBT30-MDQ26- 60	26	60	50	50	37.5	-	16~70	1
No.40	NBT40-MDQ26- 65	26	65	50	54	30.0	1.3	16~70	2
No.50	NBT50-MDQ26- 80	26	80	50	87	22.0	4.6	16~70	2
	(NIT50)-MDQ34- 90	34	90	64	87	32.0	4.9	16~85	
	-MDQ42-100	42	100	83	87	45.0	5.7	16~180	

- ★All base holders are used for centre through tool coolant.
- ★Coupling bolt and wrench are supplied as standard.
- ★ZMAC-V head is recommended to use with the MAJOR DREAM base holder for anti-vibration.
- ★When L length is required longer than standard, please specify the boring depth M and Q No.



2LOCK

2LOCK BASE HOLDER for MODULAR TYPE

NIKKEN

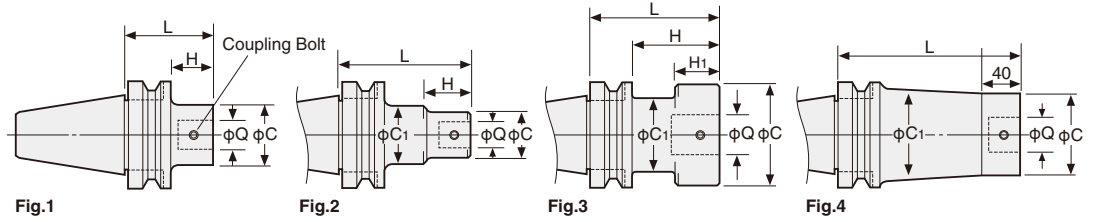

TAPER	Code No.	Coupling Dia Q	L	C	C ₁	H	H ₁	Coupling Bolt No.	Fig.	Weight(kg)
No.30	NBT30-Q 9- 50	9	50	19	30	20		B19	2	0.5
	-Q12- 65	12	65	24		40		B12	1	
	-Q16- 50	16	50	31	-	25		B16		
	-Q20- 50	20		40		26		B20		
	-Q26- 40	26	40	50	45	18	6	B26N	3	
No.40	NBT40-Q 9- 80, 95N	9	80,95	19	30	5,27		B19	2	1.2, 1.2
	(NIT40)-Q12- 80,110	12	80,110	24	35	12,50		B12		1.2, 1.3
	-Q16- 95,125	16	95,125	31	42	22,55		B16		1.5, 1.6
	-Q20- 80,110	20	80,110	40	50	27,60		B20	1	1.5, 1.7
	-Q26- 50, 95,140	26	50,95,140	50	-	20,65,110		B26N		1.1, 1.8, 2.4
	-Q34- 95,110	34	95,110	64	62	68,83	55,70	B34	3	2.2, 2.6
	-Q42- 95	42	95	83	62	68	55	B42		2.8
No.50	NBT50-Q 9-110,125N	9	110,125	19	40	5,27		B19	2	4.1, 4.1
	(NIT50)-Q12- 95,125	12	95,125	24	44	12,50		B12		4.0, 4.0
	-Q16-125N,155	16	125,155	31	50	22,55		B16		4.5, 4.6
	-Q20-110,125	20	110,125	40	60	27,60		B20	1,2,2	4.6, 4.5
	-Q26- 65,140,170N	26	65,140,170	50	65	27,47,112		B26N		3.7, 5.3, 5.4
	-Q34-140,170,200	34	140,170,200	64	80	102,120,150		B34	1,2,2	5.6, 6.5, 7.1
	-Q42-125,190		125,190	83	-	87,152				1
-Q42-225A,275A 325A,375A	42	225,275 325,375	83	98	-			B42	4	12.9, 15.6 18.3, 21.0

- ★All base holders have a centre through-tool coolant hole.
- ★The Coupling screw & wrench are supplied as standard.
- ★When L length is required longer than standard, please specify the boring depth M.

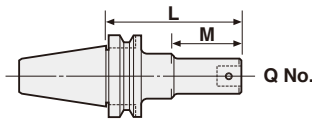

2LOCK DJ BORING BAR

NIKKEN

For both wide range small quantity production and mass production
Boring Head with **Power of Solid Carbide DJ Bit**

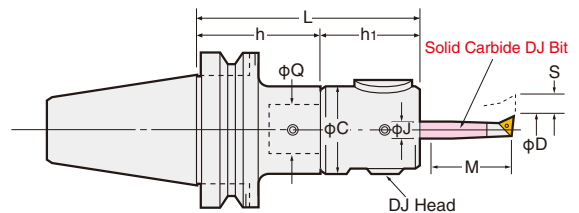

TAPER	Code No.	Boring Range	Boring Depth	L	C	Bit Hole Size	Shank Code No.	Head Code No.	Bit Stroke	DJ Bit Code No.
						J				
No.30	NBT30-DJ3- 80A	3~28	14~ 80	80	50	10	NBT30-Q26- 40	Q26-DJ3-40A	5.2	J10
	-DJ8- 84AN	3~50	14~130	84	59	16		-DJ8-44AN	6.0	J16
No.40	NBT40-DJ3- 90A	3~28	14~ 80	90	50	10	NBT40-Q26- 50	Q26-DJ3-40A	5.2	J10
	(NIT40) -135A			135		- 95				
	-DJ8- 94AN	3~50	14~130	94	59		16	NBT40-Q26- 50	-DJ8-44AN	6.0
	-139AN			139		- 95				
No.50	NBT50-DJ3-105A	3~28	14~ 80	105	50		10	NBT50-Q26- 65	Q26-DJ3-40A	5.2
	(NIT50) -210A			210		-170N				
	-DJ8-109AN	3~50	14~130	109	59		16	NBT50-Q26- 65	-DJ8-44AN	6.0
	-214AN			214		-170N				

- ★MIN. dial readout on dia.: 0.01mm, Sub scale: 0.005mm, 0.8mm/rev.
- ★Shank and DJ Head (including Boring Bits) are delivered in separate packages.
- ★Each boxed set of DJ3 and DJ8 Boring Bars include 4 pcs of DJ Boring Bits as standard.
- ★Please refer P.36 for Boring Bits. Please refer P.87 for cutting condition.
- Bits included for NBT40-DJ8-94A : J16-8-40, J16-18-80, J16-28-85, J16-38-85
- Bits included for NBT40-DJ8-94AN : J16-8-40, J16-18-60, J16-28-65, J16-38-65
- ★DJ Boring Bar without Boring Bits is also available. Please add "-BD" at the end of Code No. e.g. NBT40-DJ3-90A-BD

2LOCK BALANCE-CUT BAC ADVANCED BORING ARBOR for LARGE DIA. NIKKEN

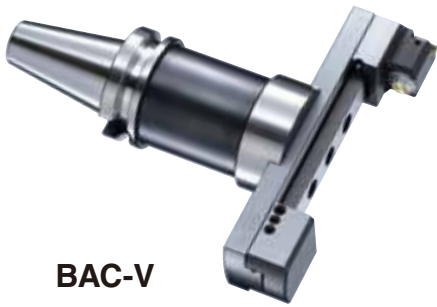

BAC-V

For Finishing

- Min. dial read out: main scale dia. 0.01mm, sub scale dia. 0.005mm
- Boring Dia: $\phi 130 \sim 595\text{mm}$

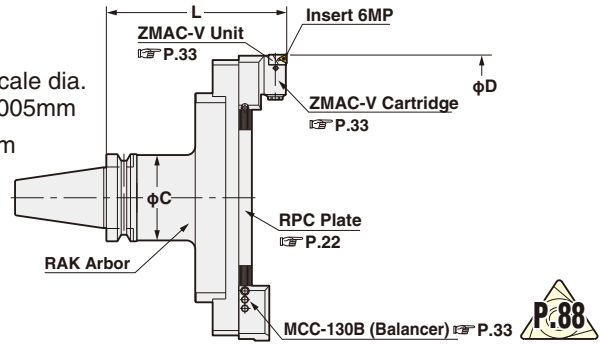

Boring Dia: $\phi 130 \sim 595\text{mm}$ for Finishing.

TAPER	Code.No	D	L	C	RAK Arbor Code No.	PPC Plante No	Cartridge (Balancer)	Weight (kg)
		MIN.~MAX.						
No.40	NBT40 -BAC130-205V	130~195	205	61	NBT40-RAK-130A	RPC-130		6.8
	(NIT40) -BAC180-205V	180~245						7.8
No.50	NBT50 -BAC130-185V, 235V, 285V	130~195	185, 235, 285	90	NBT50-RAK-110A, 160A, 210A	RPC-130	MCCZ-130V (MCC-130B) Insert Tip 6MP	13.0, 14.5, 17.5
	(NIT50) -BAC180-185V, 235V, 285V	180~245						13.5, 15.0, 18.0
	-BAC230-185V, 235V, 285V	230~295						14.0, 15.5, 18.5
	-BAC280-185V, 235V, 285V	280~345	14.5, 16.0, 19.0					
	-BAC330-210V*	330~395	210 (220*)	98	NBT50-RAK330-125 NIT50-RAK330-135*	RPC-330		16.2
	-BAC380-210V*	380~445				-380		16.5
	-BAC430-210V*	430~495				-430		17.5
	-BAC480-210V*	480~545				-480		18.5
	-BAC530-210V*	530~595				-530		19.5

- ★ "C" grade (Coated) Inserts are supplied as standard. ★ Please refer P.86 for cutting condition.
- ★ Unit "M5HZ-55V" is provided as standard, please refer P.22 for Arbor (RAK) and Plate (RPC).
- ★ Arbor, Plate and Cartridge are delivered in separate packages.
- ★ When ordering, please let us know machine maker and model no. to avoid the interference with tool magazine of ATC.
- ★ The location of cutting edge is same as drive key in standard.
- The different location is available, please specify θ in Code No. e.g. NBT50-BAC180-235V-90°
- ★ The boring arbors marked*with NIT50, L (gauge length) is 220. e.g. NIT50-BAC330-220V

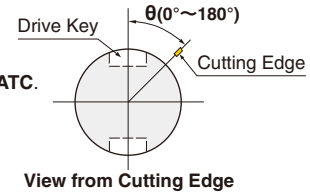

2LOCK BALANCE-CUT RAC BORING ARBOR for LARGE DIA. NIKKEN



RAC

For Roughing

- With slight adjust screw
- Boring Dia: $\phi 130 \sim 580\text{mm}$

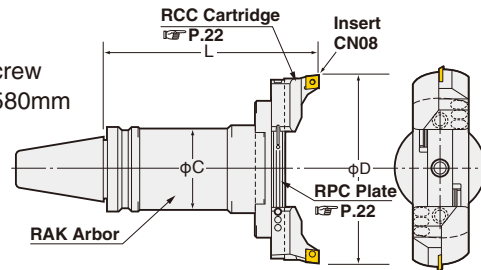

Boring Dia: $\phi 130 \sim 580\text{mm}$ for Roughing.

TAPER	Code.No	D	L	C	RAK Arbor Code No.	PPC Plante No	Cartridge No. for Large dia.	Weight (kg)
		MIN.~MAX.						
No.40	NBT40 -RAC130-205	130~180	205	61	NBT40-RAK-130A	RPC-130		6.8
	(NIT40) -RAC180-205	180~230						7.8
No.50	NBT50 -RAC130-185, 235, 285	130~180	185, 235, 285	90	NBT50-RAK-110A, 160A, 210A	RPC-130	For Heavy Duty Boring of Iron and Cast Iron RCC-130 x2 Insert Tip CN08	11.3, 12.8, 15.8
	(NIT50) -RAC180-185, 235, 285	180~230						11.8, 13.3, 16.3
	-RAC230-185, 235, 285	230~280						12.3, 13.8, 16.8
	-RAC280-185, 235, 285	280~330	12.8, 14.3, 17.3					
	-RAC330-210*	330~380	210 (220*)	98	NBT50-RAK330-125 NIT50-RAK330-135*	RPC-330		15.5
	-RAC380-210*	380~430				-380		16.5
	-RAC430-210*	430~480				-430		17.5
	-RAC480-210*	480~530				-480		18.5
	-RAC530-210*	530~580				-530		19.5

- ★ The Code No. on above table are the boring arbors with RCC-130 cartridge (Insert tip: CN08) the Heavy Duty Boring of Iron and Cast Iron. Please refer P.85 for cutting condition.
- ★ Boring arbor with cartridges & insert for Steel, Stainless Steel and Cast Iron (E), for Aluminum (A) and for Through Hole & Multi Sheets (K) are available. Please refer P.22 for cartridges. e.g. NBT50-RAC130-185E
- ★ Arbor, Plate and Cartridge are delivered in separate packages.
- ★ When ordering, please let us know machine maker and model no. to avoid the interference with tool magazine of ATC.
- ★ The location of cutting edge is same as drive key in standard. The different location is available, please specify θ in Code No. e.g. NBT50-RAC180-235-90°
- ★ The boring arbors marked*with NIT50, L (gauge length) is 220. e.g. NIT50-RAC330-220

Innovational Design! Double Contact · 1/10 Short Taper

Since the launch of the NC5 TOOLING SYSTEM at JIMTOF'94, OSAKA the system has proven its outstanding ability is a wide cross-sector of Japanese Industry, with ever-increasing expectation of its being adapted as the Next Generation Tooling Interface.

Please take a moment to look at the NC5 TOOLING SYSTEM before you purchase your next machine. NC TOTAL TOOLING SYSTEM P.279~281

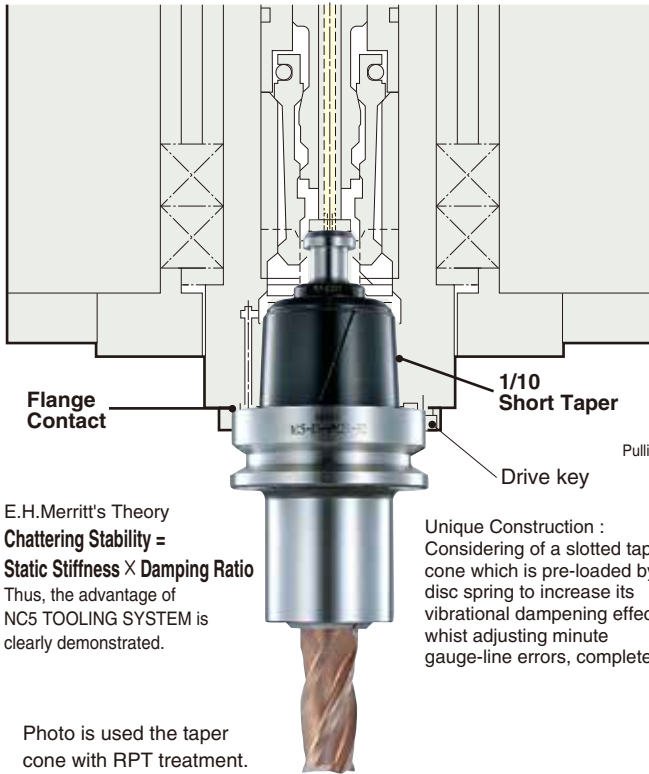

E.H.Merritt's Theory
Chattering Stability = Static Stiffness × Damping Ratio
Thus, the advantage of NC5 TOOLING SYSTEM is clearly demonstrated.

Unique Construction :
Considering of a slotted taper cone which is pre-loaded by a disc spring to increase its vibrational dampening effect whilst adjusting minute gauge-line errors, completely.

Photo is used the taper cone with RPT treatment.

NC5 is an abbreviation of New Century arbor with 1/10 taper (5°43' 29").

1/10 and 7/24 Taper

The following diagrams show the correlation between Pulling Force/ Taper Angle and their Static Stiffness. As can be seen, using the same Pulling Force, the smaller the Taper Angle, the greater the Static Stiffness. Therefore, the larger the Taper Angle, the greater the Pulling Force is required. For example, 12KN of Pulling Force is required for a 7/24 taper to obtain the same value of Static Stiffness as a 1/10 taper using a 4KN Pulling Force.

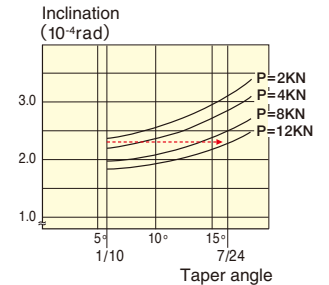
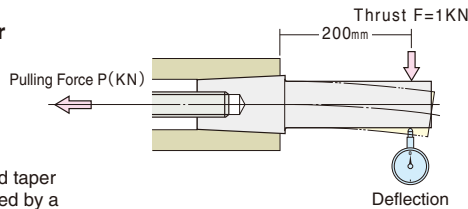

Repeatability

Higher Repeatability is accomplished due to run-out accuracy of contact flange for taper is within 0.002mm.

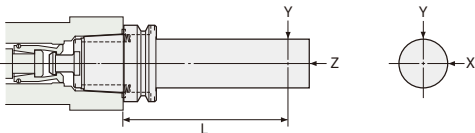

TAPER	Equivalent	L	Repeatability		
			X	Y	Z
NC5- 46	BT30	70	0.003	0.003	0.002
- 63	BT40	120	0.003	0.003	0.002
- 85	BT45	150	0.003	0.003	0.002
-100	BT50	180	0.003	0.003	0.002

Pulling Force and Static Stiffness

The NC5-63 takes advantage of the taper/Pulling Force to increase its Static Stiffness such that under a force of 5.5 kN the Static Stiffness of an NC5-63 and BT40 are almost the same. But at 12 kN the Static Stiffness of an NC5-63 is three times that of a BT40.

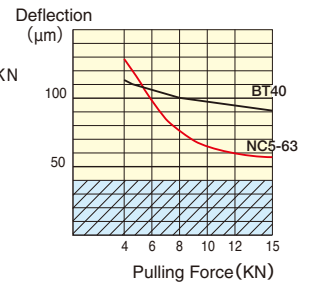
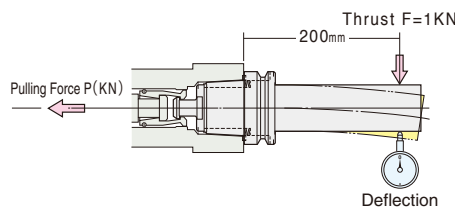

means Deflection of Test Bar itself.

ATC

Clamp Action ... Cleaning Air is same as Unclamp Action.

- When tool is inserted into a spindle, there is no contact between the taper or flange.
- Taper makes contact and centres.
- Further retraction causes simultaneous contact of the taper and the flange with spindle.

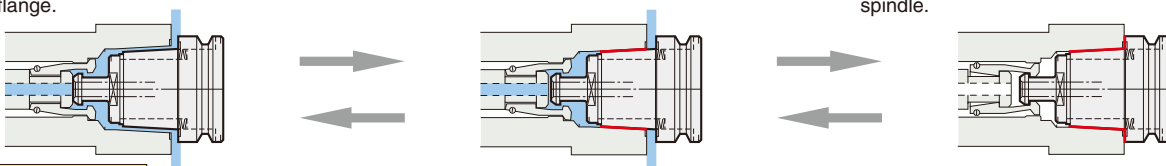

Unclamp Action

- Taper is detached and air blast cleans the taper.
- Flange is detached slightly and high pressure air blast cleans the flange.
- As the pull stud is released, an air blast is activated inside the spindle.

Innovational Design! Double Contact · 1/10 Short Taper

Face Milling



S53C

Comparison of Milling Capability using extended cutter

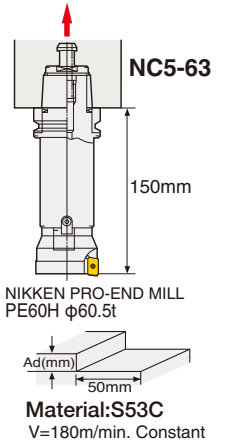
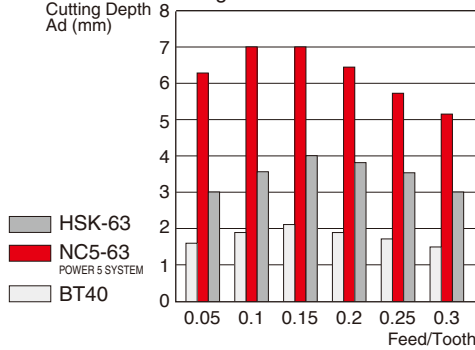

End Milling

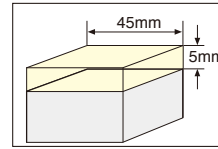

Material: SCM415
V=300m/min. f=0.3mm/tooth
S=3800min⁻¹ F=4560mm/min.

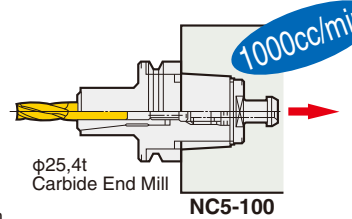

1 to 1 Scale Swarf of SCM415

Stiffness & Dampening Effect

Drilling



SCM435

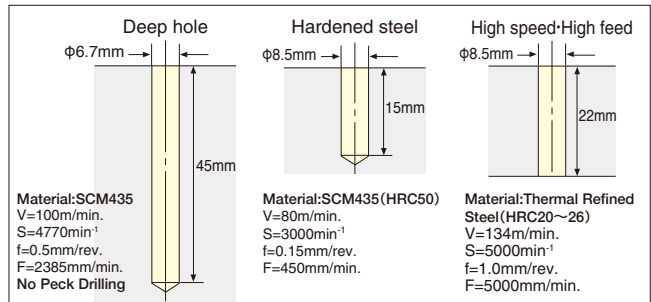
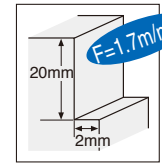
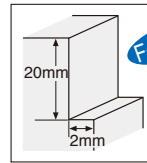

Boring



Current developments in inserts (coated TiAlN & CBN) and their improved capability for high speed cutting is remarkable. However, the results are based on using these inserts with high-speed cutting conditions (their performance is reduced when used for medium or low cutting speeds). The ZMAC Boring Head has been designed to optimise this new high-speed cutting technology.

■ Cutting data
M/C : VC8
Holder : NC5-63-Q26-50
SP26-12-30
12-ZMAC16-45
External coolant
Insert : 3MP-C Nose/R=0.2
Coating (Coated TiAlN)

Cutting Speed: V=200m/min, 350m/min.
f=0.05mm/rev. for both
Feed : 0.5mm dia.

V=350m/min. gave better finish & accuracy

Material: S53C Thermal refined carbon steel.

Material: S53C Thermal refined carbon steel

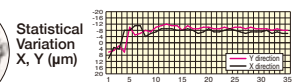
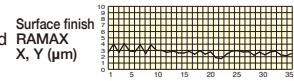
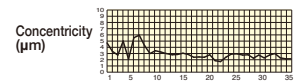
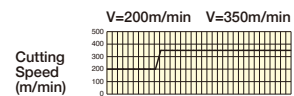

Measurement of 35 bores on end

NC5 ZMAC ADVANCED BORING ARBOR (ZMAC-V)



Boring for Finishing

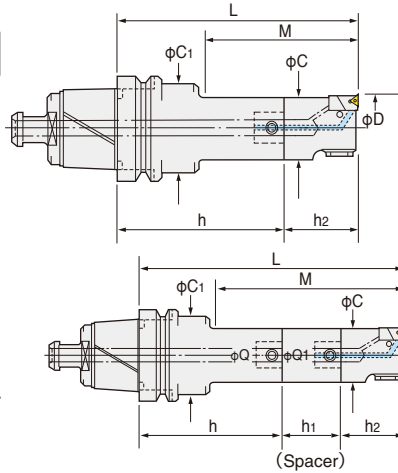

No Micro Vibration due to Double-Contact Support of Cartridge. Long Tool-Life & High Accuracy.

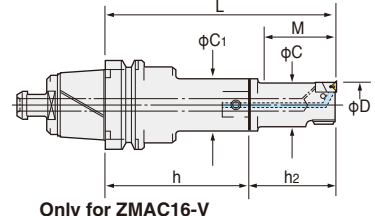
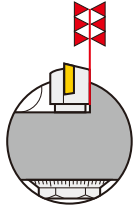

Only for ZMAC16-V

ZMAC-V

Photo shows ZMAC α -V head with A1 spacer.

All codes shown are for heads with triangular inserts For heads with rhomboid inserts please add the letter "R" to the code No. e.g. NC5-63-ZMAC32 R -150V

TAPER	Code No.	Boring Range D	Boring Depth M	P.88		Weight (kg)	
				Head No.	Insert No.		
NC5-63	NC5- 63-ZMAC16-125V,135V	15.9~20.2	38, 48	12-ZMAC16-45V,55V	3MP-C,B	1.6, 1.6	
	-ZMAC20-120V, 135V, 150V	19.8~25.2	45, 67, 75	9-ZMAC 20- 40V		1.6, 1.6, 1.7	
	-ZMAC25-120V, 150V, 165V	24.8~32.2	52, 90, 97	12-ZMAC 25- 40V	1.7, 1.8, 1.8		
	-ZMAC32-150V, 180V, 195V	31.8~42.2	77, 110, 122	16-ZMAC 32- 55V	4MP-C,B	2.2, 2.4, 2.4	
	-ZMAC42-150V, 180V, 210V	41.8~55.2	97, 130, 157	20-ZMAC 42- 70V	6MP-C,B	2.7, 2.9, 3.2	
	-ZMAC55-165V, 210V, 225V	54.8~70.2	135, 180, 195	26-ZMAC 55- 70V		3.6, 4.3, 4.3	
	-ZMAC70-165V, 180V, 225V	69.8~85.2	165, 180, 225	34-ZMAC 70- 70V		5.1, 5.5, 6.5	
	-ZMAC85-195V	84.8~100.2	195	42-ZMAC 85-100V		8.7	
NC5-85	NC5- 85-ZMAC16-140V, 150V	15.9~20.2	38, 48	12-ZMAC16-45V,55V	3MP-C,B	2.9, 2.9	
	-ZMAC20-150V, 165V, 180V	19.8~25.2	45, 67, 75	9-ZMAC 20- 40V		3.0, 3.0, 3.1	
	-ZMAC25-135V, 165V, 180V	24.8~32.2	52, 90, 97	12-ZMAC 25- 40V	4MP-C,B	3.7, 3.8, 3.9	
	-ZMAC32-180V, 210V, 225V	31.8~42.2	77, 110, 122	16-ZMAC 32- 55V		6MP-C,B	4.2, 4.2, 4.6, 4.7
	-ZMAC42-180V, 195V, 225V, 240V	41.8~55.2	97, 130, 142, 157	20-ZMAC 42- 70V			5.7, 5.8, 7.3
	-ZMAC55-210V, 240V, 270V	54.8~70.2	117, 182, 177	26-ZMAC 55- 70V	8.2, 8.8, 9.7		
	-ZMAC70-240V, 270V, 300V	69.8~85.2	190, 220, 250	34-ZMAC 70- 70V	10.7, 13.2, 14.2		
		-ZMAC85-225V, 290V, 315V	84.8~100.2	187, 252, 277	42-ZMAC 85-100V	12.0, 14.7, 14.6	
	-ZMAC100-225V, 290V, 315V	99.5~140.5	225, 290, 315	42-ZMAC100-100V	12.8, 15.5, 16.2		
	-ZMAC140-225V, 290V, 315V	139.5~180.5		42-ZMAC140-100V			
NC5-100	NC5-100-ZMAC16-140V, 150V	15.9~20.2	38, 48	12-ZMAC16-45V,55V	3MP-C,B	3.9, 3.9	
	-ZMAC20-150V, 165V, 180V	19.8~25.2	45, 67, 75	9-ZMAC 20- 40V		4.0, 4.0, 4.1	
	-ZMAC25-135V, 165V, 180V	24.8~32.2	52, 90, 97	12-ZMAC 25- 40V	4MP-C,B	4.7, 4.8, 4.9	
	-ZMAC32-180V, 210V, 225V	31.8~42.2	77, 110, 122	16-ZMAC 32- 55V		6MP-C,B	5.2, 5.2, 5.6, 5.7
	-ZMAC42-180V, 195V, 225V, 240V	41.8~55.2	97, 130, 142, 157	20-ZMAC 42- 70V			6.7, 6.8, 8.3
	-ZMAC55-210V, 240V, 270V	54.8~70.2	117, 182, 177	26-ZMAC 55- 70V	9.2, 9.8, 10.7		
	-ZMAC70-240V, 270V, 300V	69.8~85.2	190, 220, 250	34-ZMAC 70- 70V	11.7, 14.2, 15.2		
		-ZMAC85-225V, 290V, 315V	84.8~100.2	187, 252, 277	42-ZMAC 85-100V	13.0, 15.7, 15.6	
		-ZMAC100-225V, 290V, 315V	99.5~140.5	225, 290, 315	42-ZMAC100-100V		13.8, 16.5, 17.2
	-ZMAC140-225V, 290V, 315V	139.5~180.5		42-ZMAC140-100V			

- ★MIN. dial readout : ZMAC25-V & smaller is 0.02mm on diameter. ZMAC32-V and larger are 0.01mm on diameter. (Sub scale : 0.005)
- ★"C" grade (Coated) insert for Steel, Stainless & Cast Iron is supplied as Standard with the head (Smooth boring & Long tool-life). We would recommend "B" grade (CBN) insert for Hardened Steel & High Speed boring of Cast Iron. Please refer P.86 for cutting condition.
- ★Please refer P.60 for Shank, and P.38 for Spacer, and P.27 for Head.
- ★Centre Through Tool Coolant function is available as standard.
- ★When L length is required longer than standard, please specify boring depth M.
- ★For NC5-46, modular connection system is applied. Please refer P.60 for Base Holder.
- ★The location of the cutting edge is same as the drive key for ZMAC16-V to ZMAC42-V.

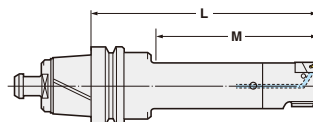

High Speed Boring ZMAC α -V P.28

NC5 BALANCE-CUT BORING ARBOR



RAC

Photo shows RAC head with A1 spacer.

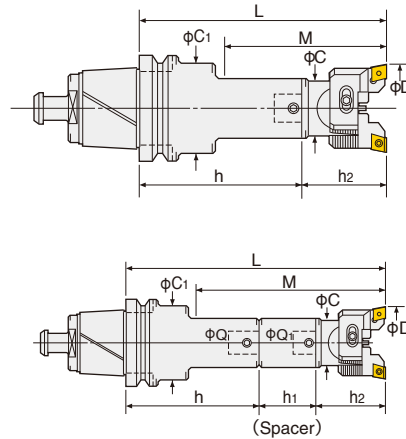

Power of Shoulder Support

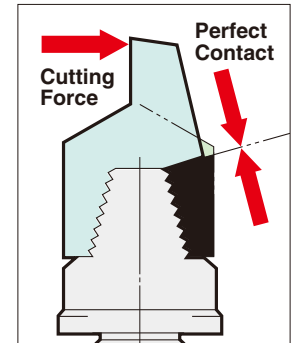

TAPER	Code No.	Boring Range D	Boring Depth M	P.12		Weight (kg)
				Head No.	Insert No.	
NC5-63	NC5- 63-RAC 25-135E, 165E, 180E	25~32	67, 105, 112	12-RAC 25- 55E	CC07-C	1.7, 1.8, 1.8
	-RAC 32-150E, 180E, 195E	32~45	77, 110, 122	16-RAC 32- 55E	CC08-C	2.1, 2.3, 2.3
	-RAC 43-150E, 180E, 210E	43~55	97, 130, 157	20-RAC 43- 70E	CC12-C	2.4, 2.6, 2.9
	-RAC 53-165E, 210E, 225E	53~70	135, 180, 195	26-RAC 53- 70E		2.2, 3.0, 2.9
	-RAC 70-180E, 195E, 240E	70~100	180, 195, 240	34-RAC 70- 85E		4.5, 4.9, 5.9
	-RAC100-195E	100~130	195	42-RAC100-100E		6.5
NC5-85	NC5- 85-RAC 25-150E, 180E, 195E	25~32	67, 105, 112	12-RAC 25- 55E	CC07-C	2.9, 3.1, 3.0
	-RAC 32-180E, 210E, 225E	32~45	77, 110, 122	16-RAC 32- 55E	CC08-C	3.6, 3.8, 3.8
	-RAC 43-180E, 195E, 225E, 240E	43~55	97, 130, 142, 157	20-RAC 43- 70E	CC12-C	3.9, 4.0, 4.3, 4.4
	-RAC 53-210E, 240E, 270E	53~70	117, 182, 177	26-RAC 53- 70E		5.1, 5.2, 5.8
	-RAC 70-255E, 285E, 315E	70~100	205, 235, 265	34-RAC 70- 85E		7.7, 8.1, 9.1
	-RAC100-225E, 290E, 315E	100~130	187, 252, 277	42-RAC100-100E		10.7, 10.7, 14.1
NC5-100	NC5-100-RAC 25-150E, 180E, 195E	25~32	67, 105, 112	12-RAC 25- 55E	CC07-C	3.9, 4.1, 4.0
	-RAC 32-180E, 210E, 225E	32~45	77, 110, 122	16-RAC 32- 55E	CC08-C	4.6, 4.8, 4.8
	-RAC 43-180E, 195E, 225E, 240E	43~55	97, 130, 142, 157	20-RAC 43- 70E	CC12-C	4.9, 5.0, 5.3, 5.4
	-RAC 53-210E, 240E, 270E	53~70	117, 182, 177	26-RAC 53- 70E		6.1, 6.2, 6.8
	-RAC 70-255E, 285E, 315E	70~100	205, 235, 265	34-RAC 70- 85E		8.7, 9.1, 10.1
	-RAC100-225E, 290E, 315E	100~130	225, 290, 315	42-RAC100-100E		11.7, 11.7, 15.1

★“C” grade (Coated) inserts are supplied as standard with the head. P.12 Please refer P.85 for cutting condition.

★Please refer P.60 for base holder, P.38 for spacer and P.19 for head.

★For centre through tool coolant type, please add“-C”at the end of Code No. e.g. NC5-63-RAC53-165-C

★Cartridges & Insert tips for the Heavy Duty Boring of Iron and Cast Iron(No letter), for Aluminum(A), and for Through Hole & Multiple Sheets(K) are available.

Please refer P.19 for cartridges. Please add the letter “No letter”, “A” or “K” at the end of Code No. e.g. NC5-63-RAC53-165A

★When L length is required longer than standard, please specify the boring depth M.

★Cartridge & Insert for Alloy Steel (E) is recommended for boring on steel and stainless steel.

e.g. NC5-63-RAC53-165E

★For NC5-46, modular connection system is applied. Please refer P.60 for Base Holder.

Code No. of RAC25 and RAC32 with CC inserts are changed to RAC25E and RAC32E.

Please refer P.11, P.12

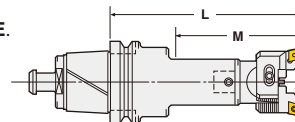

High Pressure Coolant Through

NC5

NC5 BALANCE-CUT BAC ADVANCED BORING ARBOR for LARGE DIA. **NIKKEN**

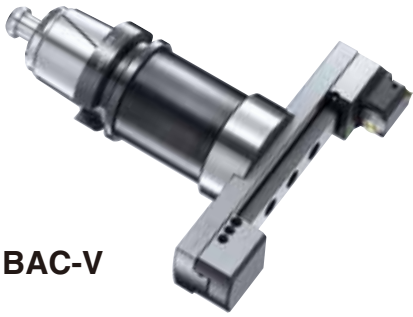

BAC-V

For Finishing

- Min. dial read out: main scale dia. 0.01mm, sub scale dia. 0.005mm
- Boring Dia: $\phi 130 \sim 595\text{mm}$

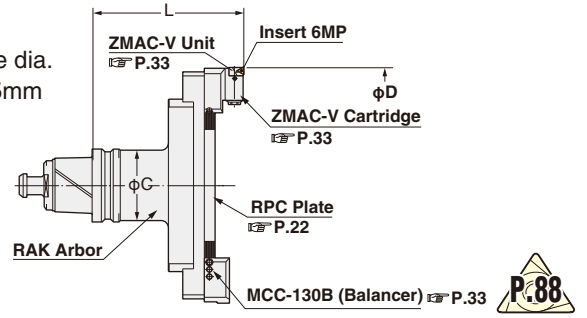

Boring Dia: $\phi 130 \sim 595\text{mm}$ for Finishing.

TAPER	Code.No	D	L	C	Arbor No.	RPC Plate No	Cartridge (Balancer)	Weight (kg)
		MIN.~MAX.						
NC5- 63	NC5-63 -BAC130-205V	130~195	205	61	NC5-63-RAK-130A	RPC-130	MCCZ-130V (MCC-130B)	6.8
	-BAC180-205V	180~245				-180		7.8
NC5- 85 NC5-100	NC5-85 -BAC130-185V, 235V, 285V (NC5-100)	130~195	185, 235, 285	90	NC5-85-RAK-110A, 160A, 210A (NC5-100)	RPC-130	MCCZ-130V (MCC-130B) Insert Tip 6MP	13.0, 14.5, 17.5
	-BAC180-185V, 235V, 285V	180~245				-180		13.5, 15.0, 18.0
	-BAC230-185V, 235V, 285V	230~295				-230		14.0, 15.5, 18.5
	-BAC280-185V, 235V, 285V	280~345				-280		14.5, 16.0, 19.0
	-BAC330-210V	330~395	210	98	NC5-85-RAK330-125 (NC5-100)	RPC-330		16.2
	-BAC380-210V	380~445				-380		16.5
	-BAC430-210V	430~495				-430		17.5
	-BAC480-210V	480~545				-480		18.5
-BAC530-210V	530~595	-530	19.5					

- ★ "C" grade (Coated) Inserts are supplied as standard. Please refer P.86 for cutting condition.
- ★ Arbor, Plate and Cartridge are delivered in separate packages.
- ★ When ordering, please let us know machine maker and model no. to avoid the interference with tool magazine of ATC.
- ★ The location of cutting edge is same as drive key in standard. The different location is available, please specify θ in Code No. e.g. NC5-100-BAC180-235V-90°

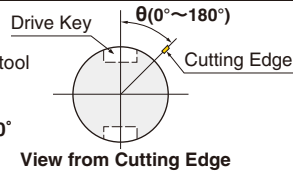

NC5 BALANCE-CUT RAC BORING ARBOR for LARGE DIA. **NIKKEN**



RAC

For Roughing

- With slight adjust screw
- Boring Dia: $\phi 130 \sim 580\text{mm}$

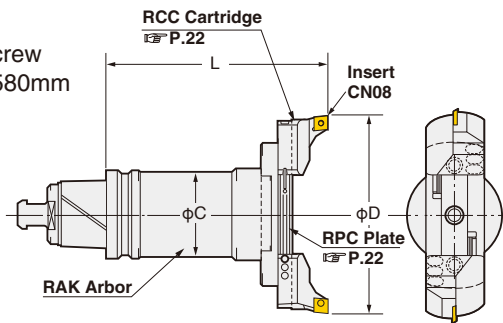

Boring Dia: $\phi 130 \sim 580\text{mm}$ for Roughing.

TAPER	Code.No	D	L	C	Arbor No.	RPC Plate No.	Cartridge No. for Large dia.	Weight (kg)
		MIN.~MAX.						
NC5- 63	NC5-63 -RAC130-205	130~180	205	61	NC5-63-RAK-130A	RPC-130		6.8
	-RAC180-205	180~230				-180		7.8
NC5- 85 NC5-100	NC5-85 -RAC130-185, 235, 285 (NC5-100)	130~180	185, 235, 285	90	NC5-85-RAK-110A, 160A, 210A (NC5-100)	RPC-130	For Heavy Duty Boring of Iron and Cast Iron RCC-130 x2 Insert Tip CN08	11.3, 12.8, 15.8
	-RAC180-185, 235, 285	180~230				-180		11.8, 13.3, 16.3
	-RAC230-185, 235, 285	230~280				-230		12.3, 13.8, 16.8
	-RAC280-185, 235, 285	280~330				-280		12.8, 14.3, 17.3
	-RAC330-210	330~380	210	98	NC5-85-RAK330-125 (NC5-100)	RPC-330		15.5
	-RAC380-210	380~430				-380		16.5
	-RAC430-210	430~480				-430		17.5
	-RAC480-210	480~530				-480		18.5
-RAC530-210	530~580	-530	19.5					

- ★ The Code No. on above table are the boring arbors with RCC-130 cartridge (Insert tip: CN08) the Heavy Duty Boring of Iron and Cast Iron. Please refer P.85 for cutting condition.
- ★ Boring arbor with cartridges & insert for Steel, Stainless Steel and Cast Iron (E), for Aluminum (A) and for Through Hole & Multi Sheets (K) are available. Please refer P.22 for cartridges. e.g. NC5-100-RAC130-185E
- ★ Arbor, Plate and Cartridge are delivered in separate packages.
- ★ When ordering, please let us know machine maker and model no. to avoid the interference with tool magazine of ATC.
- ★ The location of cutting edge is same as drive key in standard. The different location is available, please specify θ in Code No. e.g. NC5-100-RAC180-235-90°

NC5 MODULAR TYPE BASE HOLDER

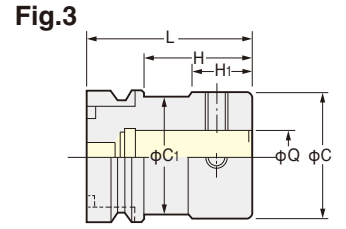
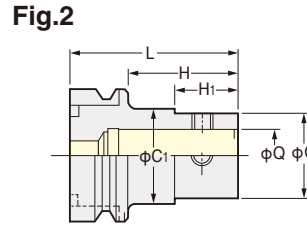
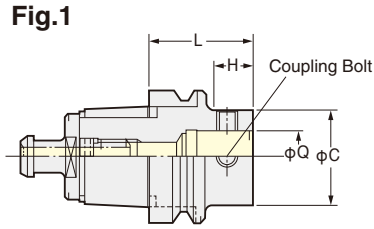

TAPER	Code No.	Coupling Dia Q	L	C	C ₁	H	H ₁	Coupling Bolt No.	Fig.	Weight(kg)
NC5- 46	NC5- 46-Q26- 40	26	40	50	45	18	6	B26N	3	0.4
NC5- 63	NC5- 63-Q 9- 80, 95	9	80, 95	19	30	48, 63	5, 27	B19	2	1.6, 1.7
	-Q12- 80, 110	12	80, 110	24	35	48, 78	12, 50	B12		1.6, 1.7
	-Q16- 95, 125	16	95, 125	31	42	63, 93	22, 55	B16		1.9, 2.1
	-Q20- 80, 110	20	80, 110	40	50	48, 78	27, 60	B20	1	2.0, 2.2
	-Q26- 50, 95, 140	26	50, 95, 140	50	—	20, 65, 110	—	B26N		0.9, 1.5, 2.3
	-Q34- 95, 110	34	95, 110	64	62	68, 83	55, 70	B34		3.0, 3.4
	-Q42- 95	42	95	83	62	68	55	B42		3.6
NC5- 85	NC5- 85-Q 9-110, 125	9	110, 125	19	40	72, 87	5, 27	B19	2	2.9, 3.1
	-Q12- 95, 125	12	95, 125	24	44	57, 87	12, 50	B12		2.5, 3.2
	-Q16-125, 155	16	125, 155	31	50	87, 117	22, 55	B16		3.6, 3.8
	-Q20-110, 125	20	110, 125	40	60	72, 87	27, 60	B20	1, 2, 2	3.7, 3.8
	-Q26- 65, 140, 170	26	65, 140, 170	50	65	27, 102, 132	—, 40, 110	B26N		2.5, 4.6, 4.7
	-Q34-140, 170, 200	34	140, 170, 200	64	80	102, 137, 167	—, 117, 147	B34		4.5, 6.4, 6.8
	-Q42-125, 190	42	125, 190	83	—	87, 152	—	B42		8.0
NC5-100	NC5-100-Q 9-110, 125	9	110, 125	19	40	67, 82	5, 27	B19	2	4.0, 4.2
	-Q12- 95, 125	12	95, 125	24	44	52, 82	12, 50	B12		4.1, 4.3
	-Q16-125, 155	16	125, 155	31	50	82, 112	22, 55	B16		4.7, 4.9
	-Q20-110, 125	20	110, 125	40	60	67, 82	27, 60	B20	1, 2, 2	4.8, 4.9
	-Q26- 65, 140, 170	26	65, 140, 170	50	65	27, 97, 127	—, 45, 110	B26N		3.6, 5.7, 5.8
	-Q34-140, 170, 200	34	140, 170, 200	64	80	97, 127, 157	—, 117, 147	B34		5.6, 7.5, 7.9
	-Q42-125, 190	42	125, 190	83	—	87, 152	—	B42		9.1

- ★All base holders have a centre through-tool coolant hole.
- ★The Coupling screw & wrench are supplied as standard.
- ★When L length is required longer than standard, please specify the boring depth M.

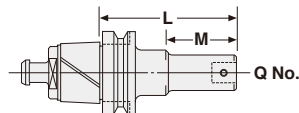

NC5 TAPER GAUGE · TEST BAR

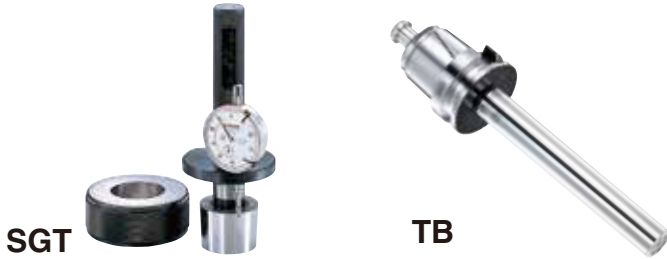

TAPER	Gauge	Test Bar(φD-L)
NC5- 46	NC5- 46-SGT	NC5- 46-TB40-200
NC5- 63	NC5- 63-SGT	NC5- 63-TB40-300
NC5- 85	NC5- 85-SGT	NC5- 85-TB40-300
NC5-100	NC5-100-SGT	NC5-100-TB40-300

★Above Code No. includes Ring GAUGE(SG-R)and Plug Gauge(SGT-P).
★Dial Gauge is not included with the Ring Gauge.

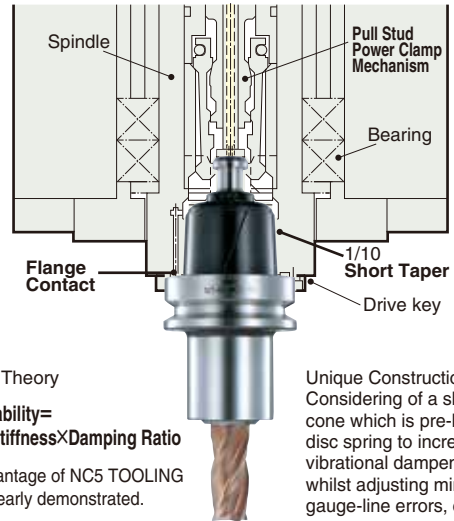

E.H.Merritt's Theory

$$\text{Chattering Stability} = \text{Static Stiffness} \times \text{Damping Ratio}$$

Thus, the advantage of NC5 TOOLING SYSTEM is clearly demonstrated.

Unique Construction:
Considering of a slotted taper cone which is pre-loaded by a disc spring to increase its vibrational dampening effect whilst adjusting minute gauge-line errors, completely.

NC5 TOOLING SYSTEM is basically developed for the Machine with Centre Through Tool Coolant capability, however, of course, the system is also suitable for the Machine without Centre Through Tool Coolant capability.

NC5 TOOLING SYSTEM takes advantage of the powerful pulling force to improve its static stiffness. Therefore, please ensure that at least the following pulling force figures in the table are required for each size of **NC5 TOOLING**. The Pulling Force Measuring Tool with special Pull Stud is available for the pulling force measurement.

For manufacturing of **NC5** Machine Spindle, we could supply the Gauge for Machine Spindle as well as any other know-how about Spindle Flange Cleaning, Drive Key Mechanism and so on. Please contact with us for any technical correspondences if required.

Pull Stud Power Clamp & Lock Mechanism

Please ask for the details of **NIKKEN POWER5 SYSTEM**, Powerful Pulling & Locking Mechanism in order to gain maximum performance of the **NIKKEN NC5 TOOLING System**.



CLP-P

TAPER	Spindle ID	POWER 5 Code No.	Pulling Force (KN)	Measuring Tool	
				Code No.	Pull Stud
NC5- 46	30	POWER5- 46-D30	4.5~ 7	S.NC5- 46-CLP-D30-P	PS-N46A
	35	-D35	5.5~ 8	-D35-P	-N46
NC5- 63	40	POWER5- 63-D40	11~14	S.NC5- 63-CLP-D40-P	-N63A
	45	-D45	14~17	-D45-P	-N63
NC5- 85	50	POWER5- 85-D50	20~23	S.NC5- 85-CLP-D50-P	-N85
NC5-100	55	POWER5-100-D55	24~27	S.NC5-100-CLP-D55-P	-N100

★Pulling Force is only guideline and depends on the M/C specification. ★Pull Stud Code No. is without hole.

★Case Size : 470x355x150

■ HSK A...HSK40A, HSK50A, HSK63A, HSK100A

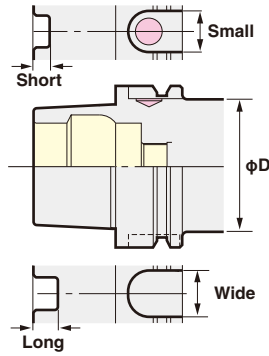
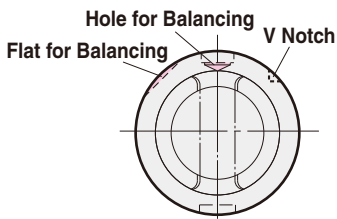

HSK A shank is based on ISO12164-1 (DIN69893-1) and Hollow Shank Taper with 1/10 Taper and Double Contact System of Taper & Flange. Its dimension is unsymmetrical shape such as;

- Depth of Drive Keys Slots are different.
- Width of U Groove are different.
- V Notch on one side.

1. It's not well balanced due to above unsymmetrical shape, therefore NIKKEN HSK A Shank has a hole and a flat for mass balancing as standard.

2. Hole for manual clamp is not standardized for the size smaller or equal to HSK50A. HSK63A and HSK100A tools without a hole for manual clamp are also available for high speed application.
3. Hole for ID is not standardized for all models.
4. HSK tool is clamped to the main spindle with clamping force more than about 2 times of BT tool by intensifying clamp mechanism.

■ Clamping Force

TAPER	HSK40A	HSK50A	HSK63A	HSK100A
Clamp Force	6.8KN	11KN	18KN	45KN

5. A big clamping force and the double face contact system of 1/10 short taper & flange largely improved the static stiffness as the tool interface.
6. Higher repeatability of ATC is accomplished due to the run-out accuracy of contact flange for taper is within 0.002mm.

■ Repeatability of ATC

TAPER	L	Repeatability		
		X	Y	Z
HSK 25	40	0.002	0.002	0.002
32	50			
40	60			
50	75			
63	100			
100	150			

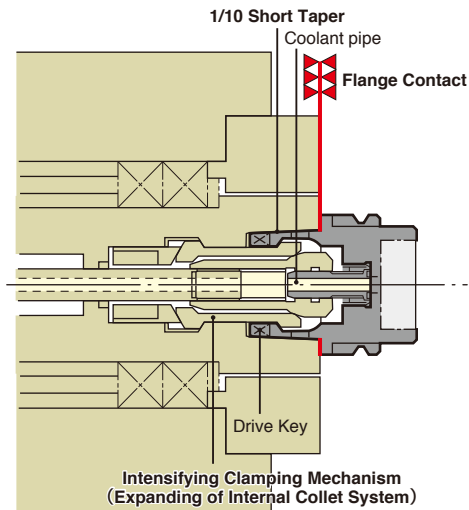
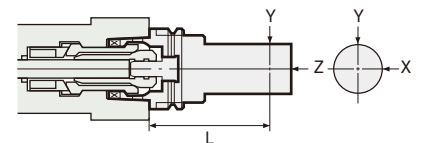

HSK Double Face Contact System

■ HSK E & HSK F...HSK25E, HSK32E, HSK40E, HSK50E, HSK63E, HSK63F

HSK-E type & HSK-F type holders are for High Speed Application and are manufactured to DIN69893-5 & -6 standard. The configuration of the holder is different to that of HSK-A type, the holder is designed symmetrically without drive key slots, U-groove, V-notch, holes in the taper for manual clamping and hole for I/D chip.

The tool flange diameter of HSK-E & -F are the same, but the taper size on HSK-F is one size smaller than HSK-E.

TCL-GH clamper is designed for symmetrical holders without drive key slots or U-groove. The TCL-GH clamper is also suitable for the other shank tooling with same flange diameter as E & F type.



■ The S/HSK40A and S/HSK63A with symmetrical drive key slots that do not correspond to the ISO and DIN standards are also available.

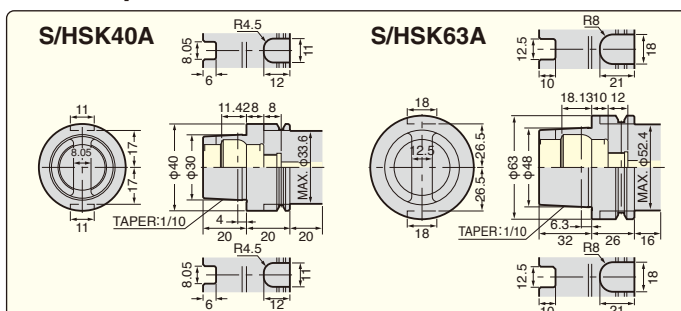

⚠ Caution

- Always ensure that swarf does not attach at the spindle flange surface, because of the double contact system. Generally the inside of the machining envelope is always covered swarf. This means that there is a possibility that the flange of the tooling may collect swarf easily at the ATC. It is therefore important that the machining envelope is regularly cleaned (Clean the ATC arm, the route through which the tooling passes, the tool pot and the spindle surfaces etc.) at least every 3 months.
- Always ensure that M/C has the mechanism to confirm the perfect flange contact.
- Always ensure that M/C has the mechanism to clean the spindle flange surface.

HSK BALANCE-CUT BORING ARBOR (RAC-E)

NIKKEN

Rough Boring — For Steel, Stainless Steel and Cast Iron
CC Insert (Positive type)



RAC-E

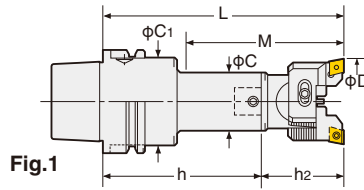

Fig.1

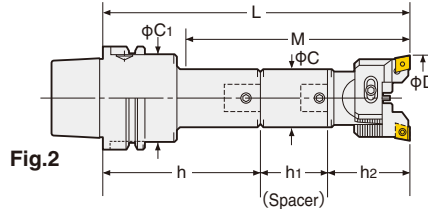

Fig.2

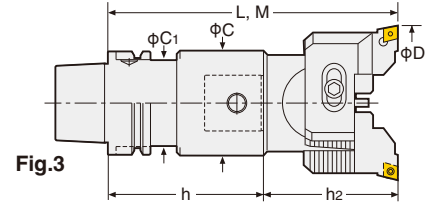

Fig.3

TAPER	Code No.	Boring Range D	Boring Depth M	C	C ₁	Shank Code No.	Spacer Code No.	P.64		Weight (kg)	Fig
								Head Code No.	Tip No.		
HSK63A	HSK 63A-RAC25-135E	25~32	67	15	24	HSK 63A-Q12- 80	—	12-RAC 25- 55E	CC07-C	1.7	1
	-165E		105			-Q12-110				1.8	
	-180E		112			-Q12- 80				SP12-12-45	
	-RAC32-150E	32~45	77	19	30	-Q16- 95	—	16-RAC 32- 55E	CC08-C	2.1	1
	-180E		110			-Q16-125				2.3	
	-195E		122			-Q16- 95				SP16-16-45	
	-RAC43-150E	43~55	97	40	50	-Q20- 80	—	20-RAC 43- 70E	CC12-C	2.4	1
	-180E		130			-Q20-110				2.6	
	-210E		157			-Q20- 80				SP20-20-60	
	-RAC53-165E	53~70	135	53	52.4	-Q26- 95	—	26-RAC 53- 70E	CC12-C	2.2	1
	-210E		180			-Q26-140				3.0	
	-225E		195			-Q26- 95				SP26-26-60	
	-RAC70-180E	70~100	180	64	52.4	-Q34- 95	—	34-RAC 70- 85E	CC12-C	4.5	3
	-195E		195			-Q34-110				4.9	
	-240E		240			-Q34- 95				SP34-34-60	
-RAC100-195E	100~130	195	83	—	-Q42- 95	—	42-RAC100-100E	—	6.5	—	

★“C” grade (Coated) inserts are supplied as standard with the head. P.64 Please refer P.85 for cutting condition.

★Please refer P.79 for base holder, P.38 for spacer and P.19 for head.

★For centre through tool coolant type, please add “-C” at the end of Code No. e.g. HSK63A-RAC53-165E-C

★For HSK40A or 50A, modular connection system is applied. Please refer P.79 for Base Holder.

★When L length is required longer than standard, please specify the boring depth M.

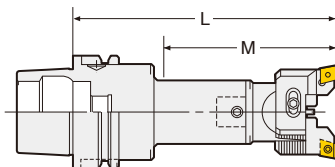

High Pressure Coolant Through Tool

HSK BALANCE-CUT BORING ARBOR (RAC-E)



Balance cut boring bar executes boring in 2 cartridge inserts absorbing the vibration each other. The faster the feed rate, the better swarf ejection. This is ideal for rough and medium boring.

Double Cutting Capability

Please use RAC-K for through hole boring.
☞ P.69, P.70

Example of 2 Stepped Balance Cut

Approx. double removal of below cutting condition is possible by -0.3 Cartridge.
☞ P.20

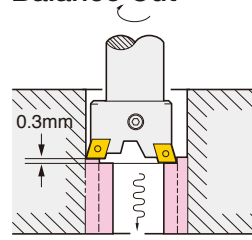
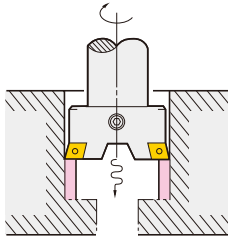

TAPER	Code No.	Boring Range D	Boring Depth M	C	C ₁	Shank Code No.	Spacer Code No.	P.64		Weight (kg)	Fig	
								Head Code No.	Tip No.			
HSK100A	HSK100A-RAC 25-150E	25~32	67	15	24	HSK100A-Q12- 95	—	12-RAC 25- 55E	CC07-C	3.9	1	
	-180E		105			-Q12-125				4.1		
	-195E		112			-Q12- 95				4.0		2
	-RAC 32-180E	32~45	77	31	50	-Q16-125N	—	16-RAC 32- 55E	CC08-C	4.6	1	
	-210E		110			-Q16-155				4.8		
	-225E		122			-Q16-125N				4.8		2
	-RAC 43-180E	43~55	97	40	60	-Q20-110	—	20-RAC 43- 70E	—	4.9	1	
	-195E		130			-Q20-125				5.0		
	225E		142			-Q20-110				5.3		2
	-240E		157			-Q20-110				5.4		
	-RAC 53-210E	53~70	117	53	65	-Q26-140	—	26-RAC 53- 70E	CC12-C	6.1	1	
	-240E		182			-Q26-170N				6.2		
	-270E		177			-Q26-140				6.8		2
	-RAC 70-255E	70~100	202	64	80	-Q34-170	—	34-RAC 70- 85E	—	8.7	1	
	-285E		232			-Q34-200				9.1		
	-315E		262			-Q34-170				10.1		2
	-RAC100-225E		225			-Q42-125				11.7		1
	-290E	290	-Q42-190	11.7								
	-315E	315	-Q42-125	15.1	2							

★“C” grade (Coated) inserts are supplied as standard with the head. ☞ P.64 Please refer ☞ P.85 for cutting condition.

★Please refer ☞ P.79 for base holder, ☞ P.38 for spacer and ☞ P.19 for head.

★For centre through tool coolant type, please add“-C”at the end of Code No. e.g. HSK100A-RAC53-210E-C

★For HSK40A or 50A, modular connection system is applied. Please refer ☞ P.79 for Base Holder.

★HSK100A-RAC100-375E, 425E and 475E are also available.

★Code No. of RAC25 and RAC32 with CC inserts are changed to RAC25E and RAC32E.

e.g. HSK100A-RAC25-150 → HSK100A-RAC25-150E
12-RAC25- 55 → 12-RAC25- 55E

Insert tip for RAC-E

● : best ○ : good

Material	Steel	Stainless Steel	Cast Iron	Aluminium	Grade	
					Coated Carbide M	Coated Carbide K
					C	
Applicable Arbor	Dimension	Code No.	Material	Grade	Material	
					Nose R	AC630M
RAC25E		CC07-○4	0.4	●	●	
					CC07-○8	0.8
RAC25E(CC08), RAC32E		CC08-○4	0.4	●	●	
					CC08-○8	0.8
RAC43E - RAC530E		CC12-○4	0.4	●	●	
					CC12-○8	0.8

Please add the grade indication into ○, and add the insert tip material indication at the end off the Code No. e.g. CC12-C8 (AC630M)

★Minimum order quantity : 10pcs.

HSK BALANCE-CUT BORING ARBOR (RAC)



Rough Boring — For Heavy Duty Boring of Iron and Cast Iron
CN Insert (Negative type)



Heavy Duty Boring

RAC

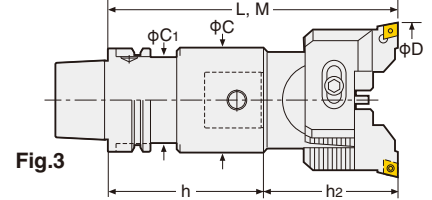
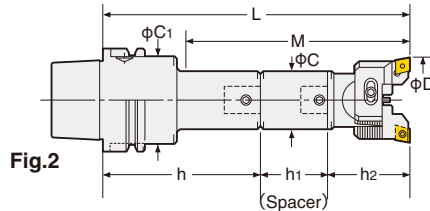
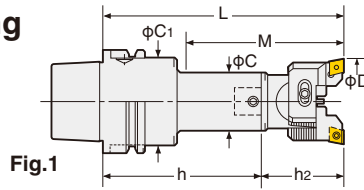

TAPER	Code No.	Boring Range D	Boring Depth M	C	C ₁	Shank Code No.	Spacer Code No.	P.66		Weight (kg)	Fig
								Head Code No.	Tip No.		
HSK63A	HSK 63A-RAC43-150	43~55	97	40	50	HSK 63A-Q20- 80	—	20-RAC 43- 70	CN08-C	2.4	1
	-180		130			SP20-20-60	2.6				
	-210		157			—	2.9				
	-RAC53-165	53~70	135	53	-Q26- 95	—	26-RAC 53- 70	2.2	1		
	-210		180		-Q26-140	—		3.0			
	-225		195		-Q26- 95	SP26-26-60		2.9			
	-RAC70-180	70~100	180	64	52.4	-Q34- 95	—	34-RAC 70- 85	CN08-C	4.5	3
	-195		195			-Q34-110	—			4.9	
	-240		240			-Q34- 95	SP34-34-60			5.9	
	-RAC100-195		100~130			195	83			-Q42- 95	

★“C” grade (Coated) inserts are supplied as standard with the head. P.66 Please refer P.85 for cutting condition.

★Please refer P.79 for base holder, P.38 for spacer and P.19 for head.

★For centre through tool coolant type, please add“-C” at the end of Code No. e.g. HSK63A-RAC53-165-C

★For HSK40A or 50A, modular connection system is applied. Please refer P.79 for Base Holder.

★When L length is required longer than standard, please specify the boring depth M.

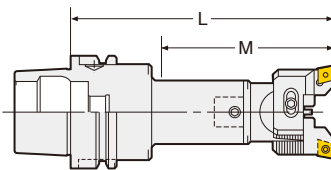

High Pressure Coolant Through Tool

HSK BALANCE-CUT BORING ARBOR (RAC)



Balance cut boring bar executes boring in 2 cartridge inserts absorbing the vibration each other. The faster the feed rate, the better swarf ejection. This is ideal for rough and medium boring.

Double Cutting Capability

Please use RAC-K for through hole boring.

☞ P.69, P.70

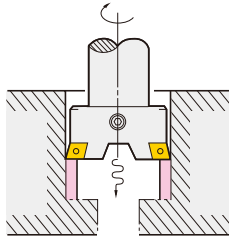

Example of 2 Stepped Balance Cut

Approx. double removal of below cutting condition is possible by -0.3 Cartridge. ☞ P.20

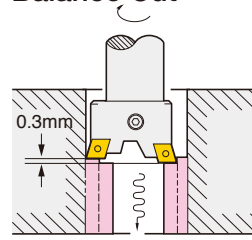

TAPER	Code No.	Boring Range D	Boring Depth M	C	C ₁	Shank Code No.	Spacer Code No.	P.66		Weight (kg)	Fig
								Head Code No.	Tip No.		
HSK100A	HSK100A-RAC 43-180	43~55	97	40	60	HSK100A-Q20-110	—	20-RAC 43- 70	CN08-C	4.9	1
	-195		130			5.0					
	225		142			5.3					
	-240		157			5.4					
	-RAC 53-210		117			6.1					
	-240	53~70	182	53	65	-Q26-140	—	26-RAC 53- 70	6.2	1	
	-270	177	6.8	2							
	-RAC 70-255	70~100	202	64	80	-Q26-170N	—	34-RAC 70- 85	CN08-C	8.7	1
	-285	232	9.1								
	-315	262	10.1								
	-RAC100-225	225	11.7								
	-290	100~130	290			83	83			-Q34-170	SP34-34-60
	-315	315	15.1	2							

- ★“C” grade (Coated) inserts are supplied as standard with the head. ☞ P.66 Please refer ☞ P.85 for cutting condition.
- ★Please refer ☞ P.79 for base holder, ☞ P.38 for spacer and ☞ P.19 for head.
- ★For centre through tool coolant type, please add“-C”at the end of Code No. e.g. HSK100A-RAC53-210-C
- ★For HSK40A or 50A, modular connection system is applied. Please refer ☞ P.79 for Base Holder.
- ★HSK100A-RAC100-375, 425 and 475 are also available.
- ★Code No. of RAC25 and RAC32 with CC inserts are changed to RAC25E and RAC32E. Please refer ☞ P.63, P.64

Insert tip for RAC for Heavy Duty Boring

Material	Steel	●	
	Stainless Steel	●	
Coated Carbide M	Cast Iron	●	
	Aluminium	○	
		Grade	C
		Material	AC630M
Applicable Arbor	Dimension	Code No.	Nose R
RAC43 - RAC530	 (CNMM120408)	CN08-○8	0.8

Please add the grade indication into ○, and add the insert tip material indication at the end of the Code No. e.g. CN08-C8(AC630M)

- ★Minimum order quantity : 10pcs.
- ★When CN08 insert (CN○1204○) in the market is used, please use the eccentric bolt type cartridge (S.RCC-○○Q) ☞ P.82. Nikken CN08-○8 insert can be used on the eccentric bolt type cartridge.

HSK

HSK BALANCE-CUT BORING ARBOR (RAC-A)

NIKKEN

Rough Boring—For Aluminium



RAC-A

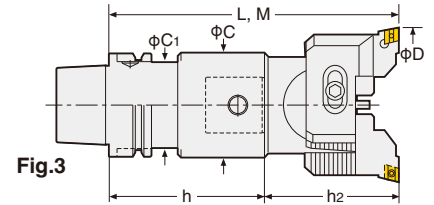
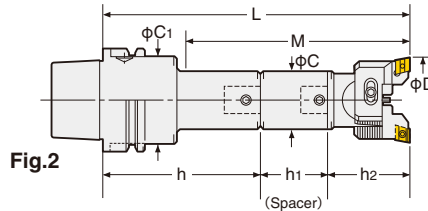
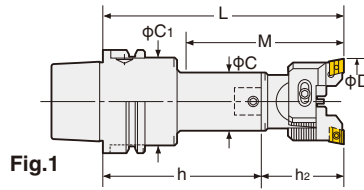

TAPER	Code No.	Boring Range D	Boring Depth M	C	C ₁	Shank Code No.	Spacer Code No.	P.68		Weight (kg)	Fig
								Head Code No.	Tip No.		
HSK63A	HSK 63A-RAC25-135A	25~32	67	15	24	HSK 63A-Q12- 80	—	12-RAC 25- 55A	AEG12	1.7	1
	-165A		105			-Q12-110	—			1.8	
	-180A		112			-Q12- 80	SP12-12-45			1.8	
	-RAC32-150A	32~45	77	19	30	-Q16- 95	—	16-RAC 32- 55A	AEG12	2.1	1
	-180A		110			-Q16-125	—			2.3	
	-195A		122			-Q16- 95	SP16-16-45			2.3	
	-RAC43-150A	43~55	97	40	50	-Q20- 80	—	20-RAC 43- 70A	AEG16	2.4	1
	-180A		130			-Q20-110	—			2.6	
	-210A		157			-Q20- 80	SP20-20-60			2.9	
	-RAC53-165A	53~70	135	53	50	-Q26- 95	—	26-RAC 53- 70A	AEG16	2.2	1
	-210A		180			-Q26-140	—			3.0	
	-225A		195			-Q26- 95	SP26-26-60			2.9	
	-RAC70-180A	70~100	180	64	52.4	-Q34- 95	—	34-RAC 70- 85A	AEG16	4.5	3
	-195A		195			-Q34-110	—			4.9	
	-240A		240			-Q34- 95	SP34-34-60			5.9	
	-RAC100-195A	100~130	195	83	—	-Q42- 95	—	42-RAC100-100A	—	6.5	—

- ★“F” grade inserts are supplied as standard with the head. P.68 Please refer P.85 for cutting condition.
- ★Please refer P.79 for base holder, P.38 for spacer and P.19 for head.
- ★For centre through tool coolant type, please add “-C” at the end of Code No. e.g. HSK63A-RAC53-165A-C
- ★For HSK40A or 50A, modular connection system is applied. Please refer P.79 for Base Holder.
- ★When L length is required longer than standard, please specify the boring depth M.

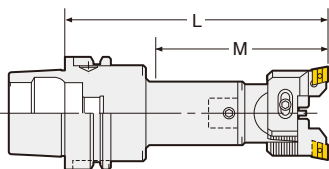

High Pressure Coolant Through Tool

HSK BALANCE-CUT BORING ARBOR (RAC-A)



Balance cut boring bar executes boring in 2 cartridge inserts absorbing the vibration each other. The faster the feed rate, the better swarf ejection. This is Ideal for rough and medium boring.

Double Cutting Capability

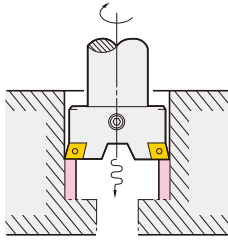

Example of 2 Stepped Balance Cut

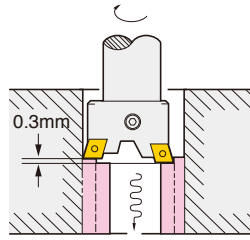

Approx. double removal of below cutting condition is possible by **-0.3 Cartridge**.
☞ P.20

TAPER	Code No.	Boring Range D	Boring Depth M	C	C ₁	Shank Code No.	Spacer Code No.	P.68		Weight (kg)	Fig
								Head Code No.	Tip No.		
HSK100A	HSK100A-RAC 25-150A	25~32	67	15	24	HSK100A-Q12- 95	—	12-RAC 25- 55A	AEG12	3.9	1
	-180A		105			-Q12-125				4.1	
	-195A		112			-Q12- 95				4.0	2
	-RAC 32-180A	32~45	77	31	50	-Q16-125N	—	16-RAC 32- 55A	AEG12	4.6	1
	-210A		110			-Q16-155				4.8	
	-225A		122			-Q16-125N				4.8	2
	-RAC 43-180A		97			-Q20-110				20-RAC 43- 70A	AEG16
	-195A	130	-Q20-125	5.0							
	225A	142	-Q20-110	5.3							
	-240A	157	-Q20-110	5.4	2						
	-RAC 53-210A	53~70	117	53	65	-Q26-140	—	26-RAC 53- 70A	AEG16	6.1	1
	-240A		182			-Q26-170N				6.2	
	-270A		177			-Q26-140				6.8	2
	-RAC 70-255A	70~100	202	64	80	-Q34-170	—	34-RAC 70- 85A	AEG16	8.7	1
	-285A		232			-Q34-200				9.1	
	-315A		262			-Q34-170				10.1	2
	-RAC100-225A		225			-Q42-125				11.7	1
	-290A	100~130	290	83	83	-Q42-190	—	42-RAC100-100A	AEG16	11.7	1
	-315A		315			-Q42-125				15.1	2

- ★“F” grade inserts are supplied as standard with the head. ☞ P.68 Please refer ☞ P.85 for cutting condition.
- ★Please refer ☞ P.79 for base holder, ☞ P.38 for spacer and ☞ P.19 for head.
- ★For centre through tool coolant type, please add“-C” at the end of Code No. e.g. HSK100A-RAC53-210A-C
- ★For HSK40A or 50A, modular connection system is applied. Please refer ☞ P.79 for Base Holder.
- ★HSK100A-RAC100-375A, 425A and 475A are also available.

Insert tip for RAC-A

Material	Steel		Code No.	Grade	Material
	Stainless Steel	Cast Iron			
	Aluminium				
					Coated Carbide K
					F
Applicable Arbor	Dimension		Nose R		KW10
RAC25A, RAC32A		AEG12-○1	0.1	●	
		AEG12-○2	0.2	●	
		AEG12-○4	0.4	●	
RAC43A-RAC530A		AEG16-○1	0.1	●	
		AEG16-○2	0.2	●	
		AEG16-○4	0.4	●	

Please add the grade indication into ○, and add the insert tip material indication at the end off the Code No. e.g. AEG16-F2 (KW10)

★Minimum order quantity : 10pcs.

HSK BALANCE-CUT BORING ARBOR (RAC-K)

NIKKEN

Rough Boring—For Through Hole and Multi Sheets



RAC-K

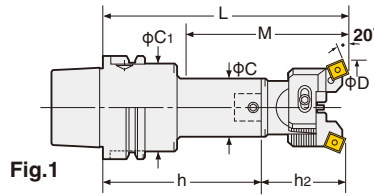

Fig.1

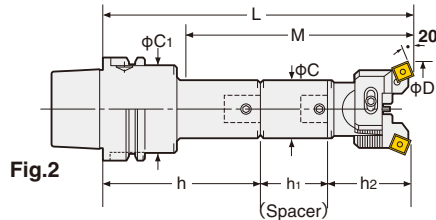

Fig.2

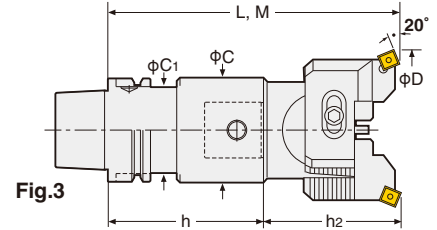

Fig.3

TAPER	Code No.	Boring Range D	Boring Depth M	C	C ₁	Shank Code No.	Spacer Code No.	P.70		Weight (kg)	Fig	
								Head Code No.	Tip No.			
HSK63A	HSK 63A-RAC25-135K	25~32	67	15	24	HSK 63A-Q12- 80	—	12-RAC 25- 55K	SC09	1.7	1	
	-165K		105			-Q12-110	—					1.8
	-180K		112			-Q12- 80	SP12-12-45					1.8
	-RAC32-150K	32~45	77	19	30	-Q16- 95	—	16-RAC 32- 55K	SC09	2.1	1	
	-180K		110			-Q16-125	—					2.3
	-195K		122			-Q16- 95	SP16-16-45					2.3
	-RAC43-150K	43~55	97	40	50	-Q20- 80	—	20-RAC 43- 70K	SC12	2.4	1	
	-180K		130			-Q20-110	—					2.6
	-210K		157			-Q20- 80	SP20-20-60					2.9
	-RAC53-165K	53~70	135	53	53	-Q26- 95	—	26-RAC 53- 70K	SC12	2.2	1	
	-210K		180			-Q26-140	—					3.0
	-225K		195			-Q26- 95	SP26-26-60					2.9
	-RAC70-180K	70~100	180	64	52.4	-Q34- 95	—	34-RAC 70- 85K	SC12	4.5	3	
	-195K		195			-Q34-110	—					4.9
	-240K		240			-Q34- 95	SP34-34-60					5.9
-RAC100-195K	100~130	195	83	—	-Q42- 95	—	42-RAC100-100K	—	6.5	—		

★“C” grade (Coated) inserts are supplied as standard with the head. P.70 Please refer P.85 for cutting condition.

★Please refer P.79 for base holder, P.38 for spacer and P.19 for head.

★For centre through tool coolant type, please add “-C” at the end of Code No. e.g. HSK63A-RAC53-165K-C

★For HSK40A or 50A, modular connection system is applied. Please refer P.79 for Base Holder.

★When L length is required longer than standard, please specify the boring depth M.



High Pressure Coolant Through Tool

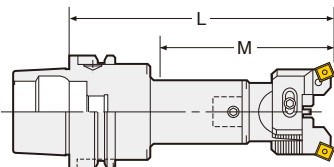

HSK BALANCE-CUT BORING ARBOR (RAC-K)



Balance cut boring bar executes boring in 2 cartridge inserts absorbing the vibration each other. The faster the feed rate, the better swarf ejection. This is Ideal for rough and medium boring.

Double Cutting Capability

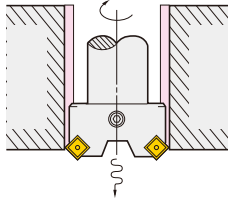

TAPER	Code No.	Boring Range D	Boring Depth M	C	C ₁	Shank Code No.	Spacer Code No.	P.70		Weight (kg)	Fig	
								Head Code No.	Tip No.			
HSK100A	HSK100A-RAC 25-150K	25~32	67	15	24	HSK100A-Q12- 95	—	12-RAC 25- 55K	SC09	3.9	1	
	-180K		105			-Q12-125				4.1		
	-195K		112			-Q12- 95				SP12-12-45	4.0	2
	-RAC 32-180K	32~45	77	31	50	-Q16-125N	—	16-RAC 32- 55K	SC09	4.6	1	
	-210K		110			-Q16-155				4.8		
	-225K		122			-Q16-125N				SP16-16-45	4.8	2
	-RAC 43-180K		43~55			97				40	60	-Q20-110
	-195K	130		-Q20-125	5.0							
	225K	142		-Q20-110	SP20-20-45	5.3	2					
	-240K	157		-Q20-110	SP20-20-60	5.4						
	-RAC 53-210K	53~70		117	53	65	-Q26-140	—	26-RAC 53- 70K			SC12
	-240K		182	-Q26-170N			6.2					
	-270K		177	-Q26-140			SP26-26-60			6.8	2	
	-RAC 70-255K		70~100	202			64			80	-Q34-170	
	-285K	232		-Q34-200	9.1							
	-315K	262		-Q34-170	SP34-34-60	10.1		2				
	-RAC100-225K	100~130		225	83	83		-Q42-125	—		42-RAC100-100K	SC12
	-290K		290	-Q42-190			11.7					
	-315K		315	-Q42-125			SP42-42-90	15.1		2		

★“C” grade (Coated) inserts are supplied as standard with the head. P.70 Please refer P.85 for cutting condition.

★Please refer P.79 for base holder, P.38 for spacer and P.19 for head.

★For centre through tool coolant type, please add “-C” at the end of Code No. e.g. HSK100A-RAC53-210K-C

★For HSK40A or 50A, modular connection system is applied. Please refer P.79 for Base Holder.

★HSK100A-RAC100-375K, 425K and 475K are also available.

Insert tip for RAC-K

● : best ○ : good

Material	Steel		Stainless Steel		Cast Iron		Aluminium	
	Coated Carbide M	Coated Carbide K	Coated Carbide M	Coated Carbide K	Coated Carbide M	Coated Carbide K	Coated Carbide M	Coated Carbide K
Applicable Arbor	Dimension	Code No.	Grade		Material		Nose R	
			AC630M	AC410K	AC630M	AC410K	AC630M	AC410K
RAC25K, RAC32K		SC09-○4	●	●	●	●	○	○
RAC43K-RAC100K		SC12-○8	●	●	●	●	○	○

Please add the grade indication into ○, and add the insert tip material indication at the end off the Code No. e.g. SC12-C8 (AC630M)

★Minimum order quantity : 10pcs.

HSK

HSK BALANCE-CUT RAC BORING ARBOR for LARGE DIA. **NIKKEN**

For Roughing

- With the screws for slight adjustment
- Boring Dia. : $\phi 130 \sim \phi 580\text{mm}$

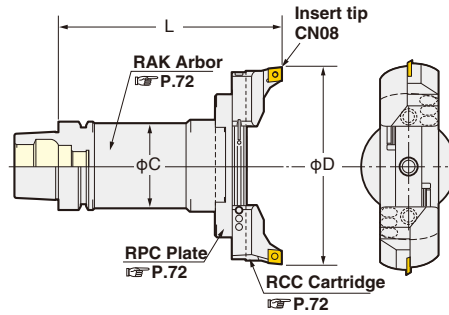

RAC

Boring Dia.: $\phi 130 \sim 580\text{mm}$

TAPE	Code.No	D	L	C	RAK Arbor Code No.	RPC Plate No.	RCC Cartridge No.	Weight (Kg)	
		MIN.~MAX.							
HSK 63A	HSK 63A-RAC130-205	130~180	205	61	HSK 63A-RAK-130A	RPC-130		6.5	
	-RAC180-205	180~230						7.5	
HSK100A	HSK100A-RAC130-185	130~180	185	90	HSK100A-RAK-110A	RPC-130	For Heavy Duty Boring of Iron and Cast Iron RCC-130 x2 Insert Tip CN08	9.3	
	-235		235		-160A			11.8	
	-285		285		-210A			14.5	
	-335		335		-260A			17.2	
	-385		385		-310A			19.9	
	-435		435		-360A			22.6	
	-485		485		-410A			25.3	
	-RAC180-185		185		-RAK-110A			11.3	
	-235	235	-160A		9.9				
	-285	285	-210A		12.4				
	-335	335	-260A		15.1				
	-385	385	-310A		17.8				
	-435	435	-360A		20.5				
	-485	485	-410A		23.2				
	-RAC230-185	185	-RAK-110A		10.6				
	-235	235	-160A		13.1				
	-285	285	-210A		15.8				
	-335	335	-260A		18.5				
	-385	385	-310A		21.2				
	-435	435	-360A		23.9				
	-485	485	-410A		26.6				
	-RAC280-185	185	-RAK-110A		11.2				
	-235	235	-160A		13.7				
	-285	285	-210A		16.4				
	-335	335	-260A		19.1				
	-385	385	-310A		21.8				
	-435	435	-360A		24.5				
	-485	485	-410A		27.2				
	-RAC330-210	330~380	210		98	HSK100A-RAK330-125		RPC-330	17.8
	-RAC380-210	380~430						-380	18.6
	-RAC430-210	430~480						-430	19.5
	-RAC480-210	480~530						-480	20.4
-RAC530-210	530~580	-530		21.2					

★The Code No. on above table are the boring arbors with **RCC-130** cartridge (Insert tip: **CN08**) the Heavy Duty Boring of Iron and Cast Iron. Please refer **P.85** for cutting condition.

★Boring arbor with cartridges & insert for Steel, Stainless Steel and Cast Iron (E), for Aluminum (A) and for Through Hole & Multi Sheets (K) are available.

Please refer **P.22** for cartridges. e.g. **HSK100A-RAC130-185E**

★Please refer **P.72** for **RAK** arbor and **RPC** plate.

★Arbor, plate and cartridges are delivered in separate packages.

★Please check the interference of the arbor with your M/C not to occur the interference in the tool magazine.

★The location of the cutting edge is same as the drive key for standard.

The different location is available, please specify θ . e.g. **HSK100A-RAC180-235-90°**

★For centre through tool coolant type, please add "C" at the end of Code No. e.g. **HSK100A-RAC130-185-C**

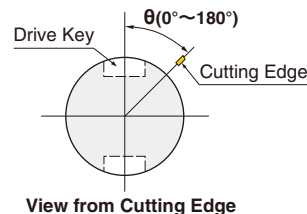

High Pressure Coolant Through Tool

HSK MODULAR TYPE ARBOR



BALANCE CUT RAK BORING ARBOR for LARGE DIA. <RAK Arbor>



RAK

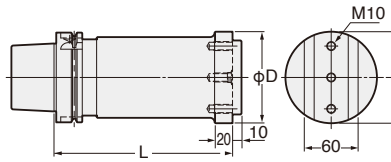

Fig.1

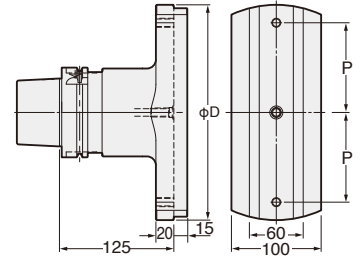
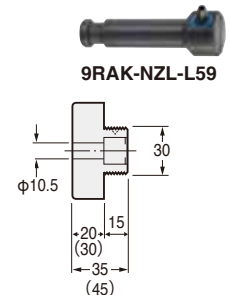
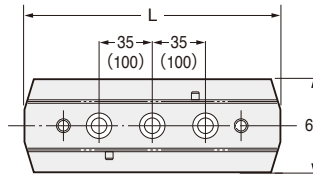

Fig.2

Code No.	Boring Range	L	D	P	Weight (Kg)	Applicable RPC Plate	Hex. Socket bolt	Fig.
HSK 63A-RAK-130A	130~230	130	102	35	4.3	RPC-130, 180	M1035	1
HSK100A-RAK-110A	130~330	110			6.7	RPC-130, 180, 230, 280		
-RAK-160A		160			9.2			
-RAK-210A		210			11.9			
-RAK-260A		260			14.6			
-RAK-310A		310			17.3			
-RAK-360A		360			20.0			
-RAK-410A	410	22.7						
-RAK330-125	330~580	125	240	100	11.3	RPC-330, 380, 430, 480, 530	M1045	2

★The location of the cutting edge is same as the drive key for standard. The different location is available, please specify θ . e.g. HSK100A-RAK-160A-90°
 ★For centre through tool coolant type, please add“-C”at the end of Code No. e.g. HSK100A-RAK-160A-C 2 set of coolant nozzles are standard accessory.

BALANCE CUT PLATE for LARGE DIA. <RPC Plate>



9RAK-NZL-L59

Dimensions in () are for RPC-330, 380, 430, 480 and 530.

Code No.	Boring Range	L	Weight(Kg)	Code No.	Boring Range	L	Weight(Kg)	Code No.	Boring Range	L	Weight(Kg)
RPC-130	130~180	118	1.4	RPC-330	330~380	316	5.3	RPC-530	530~580	516	8.7
-180	180~230	166	2.0	-380	380~430	366	6.1				
-230	230~280	216	2.7	-430	430~480	416	7.0				
-280	280~330	266	3.3	-480	480~530	466	7.9				

Accessories for RAC Balance-Cut Boring Arbor



Cartridge Lock Bolt

Please remove the bolt when using RAC-130 type for $\phi 130 \sim 157$ mm.

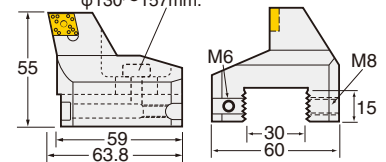

Weight : 0.6Kg

Accessories	Insert Tip	Clamp Bolt	Adjust Screw	Adjust Wrench	Wrench for Insert	Set Screw (M8)	L-Wrench for M815 Bolt	Hex Socket Bolt	Applicable RPC Plate
Code No.	*	CSM-70	M540	M3	20S	M815	M4	M625	RPC-130,180,230,280,330,380,430,480,530

★*: The insert tip is RCC-130: CN08 (P.14), RCC-130E: CC12 (P.12), RCC-130A: AEG16 (P.16), RCC-130K: SC12 (P.18)
 Please refer P.85 for cutting condition.

★There are two different types clamping system. One is eccentric system, the other is screw on system. Above parts are for screw on system.

★Code No. RCC-130 indicates a single cartridge. When ordering a pair cartridge, please appoint to us Code No. S.RCC-130.

★The Code No. of the cartridges for 2 stepped balance cut is SRCC-130(0.3).

★When CN08 insert (CN00120400) in the market is used, please use the eccentric bolt type cartridge (S.RCC-130Q).
 Nikken CN08-08 insert can be used on the eccentric bolt type cartridge.

HSK

HSK ZMAC ADVANCED BORING ARBOR (ZMAC-V)



Boring for Finishing



ZMAC-V

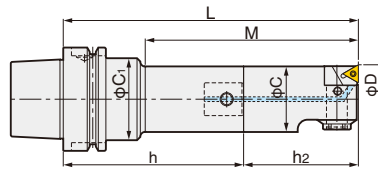

Fig.1

Only for ZMAC16-V

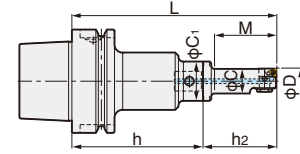

Fig.3

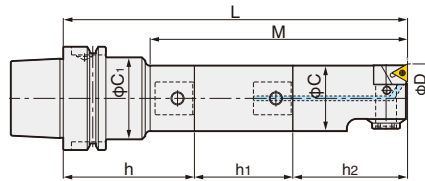

Fig.2

ZMAC100-V, 140-V

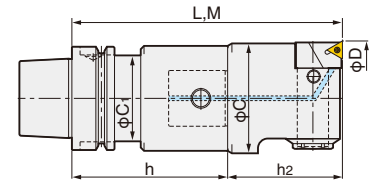

Fig.4

Code No. of the insert tip are shown.

TAPER	Code No.	Boring Range D	Boring Depth M	C	C ₁	Shank Code No.	Extension Spacer Code No.	P.88		Weight (kg)	Fig	
								Head No.	Insert No.			
HSK63A	HSK63A-ZMAC16-125V	15.8~20.2	38	15	24	HSK63A-Q12- 80	—	12-ZMAC16- 45V	3MP-C,B	1.6	3	
	-135V		48					12-ZMAC16- 55V		1.6		
	-ZMAC20-120V	19.8~25.2	45	19	30	-Q 9- 80	—	9-ZMAC20- 40V		1.6	1	
	-135V		67					-Q 9- 95N		1.6		
	-150V		75					-Q 9- 80		SP 9- 9-30	1.7	2
	-ZMAC25-120V	24.8~32.2	52	24	35	-Q12- 80	—	12-ZMAC25- 40V		1.7	1	
	-150V		90					-Q12-110		1.8		
	-165V		97					-Q12- 80		SP12-12-45	1.8	2
	-ZMAC32-150V		77					-Q16- 95		—	16-ZMAC32- 55V	4MP-C,B
	-180V	31.8~42.2	110	31	42	-Q16-125	—	16-ZMAC32- 55V		2.4	1	
	-195V	122	-Q16- 95	SP16-16-45	2.4	2						
	-ZMAC42-150V	41.8~55.2	97	40	50	-Q20- 80	—	20-ZMAC42- 70V		2.7	1	
	-180V		130					-Q20-110		2.9		
	-210V		157					-Q20- 80		SP20-20-60	3.1	2
	-ZMAC55-165V		135					-Q26- 95		—	26-ZMAC55- 70V	6MP-C,B
	-210V	54.8~70.2	180	53	50	-Q26-140	—	26-ZMAC55- 70V		4.3	1	
	-225V	195	-Q26- 95	SP26-26-60	4.3	2						
	-ZMAC70-165V	69.8~85.2	165	67	52.4	-Q34- 95	—	34-ZMAC70- 70V		5.1	4	
-180V	180		-Q34-110					5.5				
-225V	225		-Q34- 95					SP34-34-60	6.5			
-ZMAC85-195V	84.8~100.2		195					83	52.4	-Q42- 95	—	42-ZMAC85-100V

★MIN. dial readout : ZMAC25-V & smaller is 0.02mm on diameter. ZMAC32-V and larger are 0.01mm on diameter.(ZMAC25-V and larger : Sub scale : 0.005mm)

★“C” grade (Coated) insert for Steel, Stainless & Cast Iron is supplied as Standard with the head (Smooth boring & Long tool-life).

P.88 Please refer P.86 for cutting condition.

We would recommend “B” grade (CBN) insert for Hardened Steel & High Speed boring of Cast Iron.

★Please refer P.79 for base holder, P.38 for spacer and P.27 for head.

★Centre Through Tool Coolant function is available as standard.

★For HSK40A or 50A, modular connection system is applied.

Please refer P.79 for Base Holder.

★When L length is required longer than standard, please specify boring depth M.

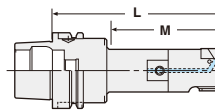

High Pressure Coolant Through Tool

Boring Arbor with Extension Spacer

ZMAC-V for Multi-Stage Boring Bar P.34,P.43

Please contact us for the special boring bar.



HSK ZMAC ADVANCED BORING ARBOR (ZMAC-V)



■ With ZMAC α -V Boring Head
Please add "AA" at the end of Code No.
e.g. HSK63A-ZMAC42-150AAV



ZMAC α -V

Diameter can be adjusted easily and quickly by new handle with wrench.



Unlock

Adjust diameter

Lock

Code No. of the insert tip are shown.

TAPER	Code No.	Boring Range D	Boring Depth M	C	C ₁	Shank Code No.	Extension Spacer Code No.	P.88		Weight (kg)	Fig		
								Head No.	Insert No.				
HSK100A	HSK100A-ZMAC 16-140V	15.8~20.2	38	15	24	HSK100A-Q12- 95	—	12-ZMAC 16- 45V	3MP-C,B	3.9	3		
	-150V		48					12-ZMAC 16- 55V					
	-ZMAC 20-150V	19.8~25.2	45	19	40	-Q 9-110	—	9-ZMAC 20- 40V	4MP-C,B	4.0	1		
	-165V		67									-Q 9-125N	
	-180V		75										SP 9- 9-30
	-ZMAC 25-135V	24.8~32.2	52	24	44	-Q12- 95	—	12-ZMAC 25- 40V	6MP-C,B	4.0	1		
	-165V		90									-Q12-125	
	-180V		97										SP12-12-45
	-ZMAC 32-180V	31.8~42.2	77	31	50	-Q16-125N	—	16-ZMAC 32- 55V	4MP-C,B	4.7	1		
	-210V		110									-Q16-155	
	-225V		122										SP16-16-45
	-ZMAC 42-180V	41.8~55.2	97	40	60	-Q20-110	—	20-ZMAC 42- 70V	6MP-C,B	5.2	1		
	-195V		130									-Q20-125	
	-225V		142										SP20-20-45
	-240V		157									-Q20-110	SP20-20-60
	-ZMAC 55-210V		54.8~70.2									117	53
	-240V	182		-Q26-170N									
	-270V	177			SP26-26-60								
	-ZMAC 70-240V	69.8~85.2		187	67	80	-Q34-170	—	34-ZMAC 70- 70V	6MP-C,B	9.2	1	
	-270V		217	-Q34-200									
	-300V		247										SP34-34-60
	-ZMAC 85-225V	84.8~100.2	187	83	—	-Q42-125	—	42-ZMAC 85-100V	6MP-C,B	11.7	1		
	-290V		252									-Q42-190	
	-315V		277										SP42-42-90
	-ZMAC100-225V	99.5~140.5	225	95	98	-Q42-125	—	42-ZMAC100-100V	6MP-C,B	11.6	4		
	-290V		290									-Q42-190	
	-325V		325										-Q42-225A
	-375V		375									-Q42-275A	
	-425V		425									-Q42-325A	
	-ZMAC140-225V		139.5~180.5									225	135
-290V	290	-Q42-190											
-325V	325			-Q42-225A									
-375V	375	-Q42-275A											
-425V	425	-Q42-325A											

★MIN. dial readout : ZMAC25-V & smaller is 0.02mm on diameter. ZMAC32-V and larger are 0.01mm on diameter.(ZMAC25-V and lager : Sub scale : 0.005mm)

★When L length is required longer than standard, please specify boring depth M. ★Centre Through Tool Coolant function is available as standard.

★"C" grade (Coated) insert for Steel, Stainless&Cast Iron is supplied as Standard with the head. (Smooth boring & Long tool-life). P.88

We would recommend "B" grade (CBN) insert for Hardened Steel & High Speed boring of Cast Iron. Please refer P.86 for cutting condition.

★Please refer P.79 for base holder, P.38 for spacer and P.27 for head.

Boring for Semi-Finishing—ZMAC-VR



ZMAC-VR

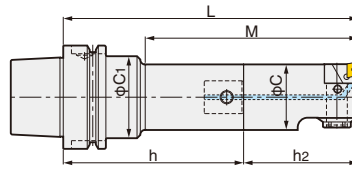

Fig.1

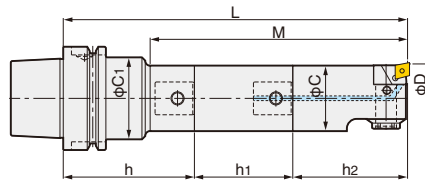

Fig.2

ZMAC100-VR, 140-VR

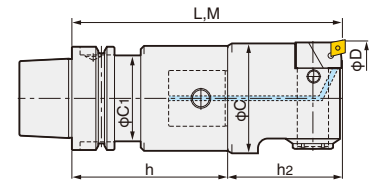

Fig.3

Code No. of the insert tip are shown.

TAPER	Code No.	Boring Range D	Boring Depth M	C	C ₁	Shank Code No.	Extension Spacer Code No.	P.76		Weight (kg)	Fig	
								Head No.	Insert No.			
HSK63A	HSK63A-ZMAC32R-150V	31.8~42.2	77	31	42	HSK63A-Q16- 95	—	16-ZMAC32R- 55V	CC06-C	2.2	1	
	-180V		110			-Q16-125						2.4
	-195V		122			-Q16- 95						SP16-16-45
	-ZMAC42R-150V	41.8~55.2	97	40	50	-Q20- 80	—	20-ZMAC42R- 70V	CC06-C	2.7	1	
	-180V		130			-Q20-110						2.9
	-210V		157			-Q20- 80						SP20-20-60
	-ZMAC55R-165V	54.8~70.2	135	53	50	-Q26- 95	—	26-ZMAC55R- 70V	CC06-C	3.6	1	
	-210V		180			-Q26-140						4.3
	-225V		195			-Q26- 95						SP26-26-60
	-ZMAC70R-165V	69.8~85.2	165	67	52.4	-Q34- 95	—	34-ZMAC70R- 70V	CC08-C	5.1	4	
	-180V		180			-Q34-110						5.5
	-225V		225			-Q34- 95						SP34-34-60
-ZMAC85R-195V	84.8~100.2	195	83	52.4	-Q42- 95	—	42-ZMAC85R-100V		8.7			

★MIN. dial readout : ZMAC32-VR and larger are 0.01mm on diameter. (Sub scale : 0.005mm)

★“C” grade (Coated) insert for Steel, Stainless & Cast Iron is supplied as Standard with the head (Smooth boring & Long tool-life).

P.88 Please refer P.86 for cutting condition.

We would recommend “B” grade (CBN) insert for Hardened Steel & High Speed boring of Cast Iron.

★Please refer P.79 for base holder, P.38 for spacer and P.27 for head.

★Centre Through Tool Coolant function is available as standard.

★For HSK40A or 50A, modular connection system is applied.

Please refer P.79 for Base Holder.

★When L length is required longer than standard, please specify boring depth M.

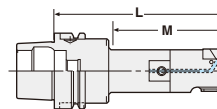

High Pressure Coolant Through Tool

Boring Arbor with Extension Spacer

ZMAC-V for Multi-Stage Boring Bar P.34,P.43

Please contact us for the special boring bar.



HSK ZMAC ADVANCED BORING ARBOR (ZMAC-VR)



Insert Tip for ZMAC-VR

●:best ○:good

Material	Steel		●	○	
	Stainless Steel		●		
	Cast Iron		○	●	
Material	Aluminium				
	High Speed finish for Cast Iron				
	Hardened Steel				
	High Speed finish for Aluminium				
		Coated Carbide M	Coated Carbide K		
		Grade	C		
		Material	AC630M	AC410K	
Applicable Arbor	Dimension	Code No.	Nose R	AC630M	AC410K
ZMAC32-VR, ZMAC42-VR, ZMAC55-VR		CC06-○4	0.4	●	●
		CC06-○8	0.8	●	●
ZMAC70-VR, ZMAC85-VR		CC08-○4	0.4	●	●
		CC08-○8	0.8	●	●
ZMAC100-VR, ZMAC140-VR		CC12-○4	0.4	●	●
		CC12-○8	0.8	●	●

Please add the grade indication into ○, and add the insert tip material indication at the end off the Code No. e.g. CC12-C8(AC630M)

There is the CBN insert tip which both corners can be used. Please refer P.88 for ISO code of the insert tip.



Code No. of the insert tip are shown.

TAPER	Code No.	Boring Range D	Boring Depth M	C	C ₁	Shank Code No.	Extension Spacer Code No.	P.76		Weight (kg)	Fig	
								Head No.	Insert No.			
HSK100A	HSK100A-ZMAC 32R-180V	31.8~42.2	77	31	50	HSK100A-Q16-125N	—	16-ZMAC 32R- 55V	CC06-C	4.7	1	
	-210V		110			-Q16-155				4.8		
	-225V		122			-Q16-125N				4.9		2
	-ZMAC 42R-180V	41.8~55.2	97	40	60	-Q20-110	—	20-ZMAC 42R- 70V	CC06-C	5.2	1	
	-195V		130			-Q20-125				5.2		
	-225V		142			-Q20-110				5.6		2
	-240V		157			-Q20-110				5.7		
	-ZMAC 55R-210V	54.8~70.2	117	53	65	-Q26-140	—	26-ZMAC 55R- 70V	CC06-C	6.7	1	
	-240V		182			-Q26-170N				6.8		
	-270V		177			-Q26-140				8.3		2
	-ZMAC 70R-240V	69.8~85.2	187	67	80	-Q34-170	—	34-ZMAC 70R- 70V	CC08-C	9.2	1	
	-270V		217			-Q34-200				9.8		
	-300V		247			-Q34-170				10.7		2
	-ZMAC 85R-225V	84.8~100.2	187	83	—	-Q42-125	—	42-ZMAC 85R-100V	CC08-C	11.7	1	
	-290V		252			-Q42-190				14.2		
	-315V		277			-Q42-125				15.2		2
	-ZMAC100R-225V	99.5~140.5	225	95	83	-Q42-125	—	42-ZMAC100R-100V	CC12-C	11.6	4	
	-290V		290			-Q42-190				14.3		
	-325V		325			-Q42-225A				17.0		
	-375V		375			-Q42-275A				19.7		
-425V	425		-Q42-325A			22.4						
-ZMAC140R-225V	139.5~180.5		225			135				83		-Q42-125
-290V		290	-Q42-190	15.7								
-325V		325	-Q42-225A	18.4								
-375V		375	-Q42-275A	21.1								
-425V		425	-Q42-325A	23.8								

★MIN. dial readout : ZMAC32-VR and larger are 0.01mm on diameter.(Sub scale : 0.005mm)

★When L length is required longer than standard, please specify boring depth M. ★Centre Through Tool Coolant function is available as standard.

★“C” grade (Coated) insert for Steel, Stainless&Cast Iron is supplied as Standard with the head (Smooth boring & Long tool-life). P.88

We would recommend “B” grade (CBN) insert for Hardened Steel & High Speed boring of Cast Iron. Please refer P.86 for cutting condition.

★Please refer P.79 for base holder, P.88 for spacer and P.27 for head.



HSK BALANCE-CUT BAC ADVANCED BORING ARBOR for LARGE DIA.

NIKKEN

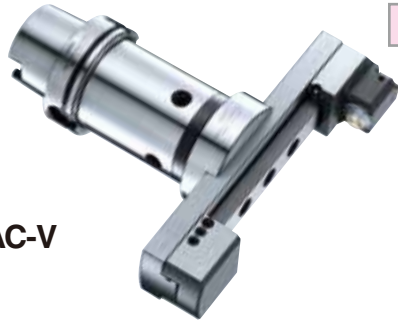

BAC-V

For Finishing

- MIN. dial readout on dia. : 0.01mm
(Sub scale : 0.005mm)
- Boring Dia : $\phi 130 \sim \phi 595\text{mm}$

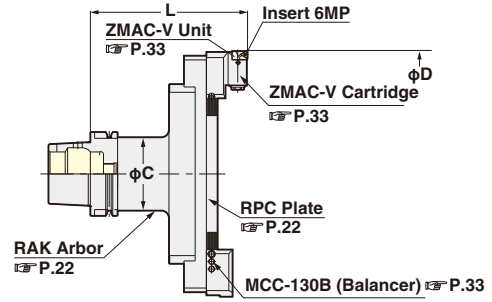

P.88

Boring Dia: $\phi 130 \sim 595\text{mm}$

TAPER	Code.No	D		L	C	RAK Arbor Code No.	PPC Plate No	Cartridge (Balancer)	Weight (Kg)
		MIN.~MAX.							
HSK 63A	HSK 63A-BAC130-205V	130~195	205	61	HSK 63A-RAK-130A	RPC-130	MCCZ-130V (MCC-130B)	Insert 6MP	6.5
	-BAC180-205V	180~245							7.5
HSK100A	HSK100A-BAC130-185V	130~195	185	90	HSK100A-RAK-110A	RPC-130	MCCZ-130V (MCC-130B)	Insert 6MP	9.5
	-235V		235						12.0
	-285V		285						14.7
	-335V		335						17.3
	-385V		385						20.1
	-435V		435						22.8
	-485V		485						25.5
	-BAC180-185V		185						10.1
	-235V	235	12.6						
	-285V	285	15.3						
	-335V	335	18.0						
	-385V	385	20.7						
	-435V	435	23.3						
	-485V	485	26.1						
	-BAC230-185V	185	10.8						
	-235V	235	13.3						
	-285V	285	16.0						
	-335V	335	18.7						
	-385V	385	21.3						
	-435V	435	24.1						
	-485V	485	26.8						
	-BAC280-185V	185	11.4						
	-235V	235	13.9						
	-285V	285	16.6						
	-335V	335	19.3						
	-385V	385	22.0						
	-435V	435	24.7						
	-485V	485	27.4						
-BAC330-210V	330~395	210	98	HSK100A-RAK330-125	RPC-330	18.0			
-BAC380-210V	380~445				-380	18.8			
-BAC430-210V	430~495				-430	19.7			
-BAC480-210V	480~545				-480	20.6			
-BAC530-210V	530~595				-530	21.4			

★“C” grade (Coated) Inserts are supplied as standard. P.88 Please refer P.86 for cutting condition.

★Unit “M5HZ-55V” is provided as standard, please refer P.246 for Arbor (RAK) and Plate (RPC).

★Arbor, Plate and Cartridge are delivered in separate packages.

★When ordering, please let us know machine maker and model no. to avoid the interference with tool magazine of ATC.

★The location of cutting edge is same as drive key in standard.

The different location is available, please specify θ in Code No. e.g. HSK100A-BAC180-235V-90°

★For centre through tool coolant type, please add “-C” at the end of Code No. e.g. HSK100A-BAC130-185V-C

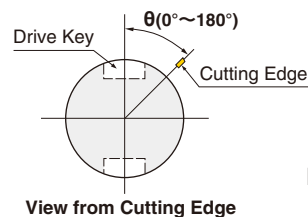

High Pressure Coolant Through Tool

HSK BALANCE-CUT BCB BORING ARBOR for LARGE DIA. **NIKKEN**



BCB

For Roughing / Finishing

- MIN. dial readout on dia. : 0.02mm (Sub scale : 0.002)
- Boring Dia : $\phi 130 \sim \phi 595\text{mm}$

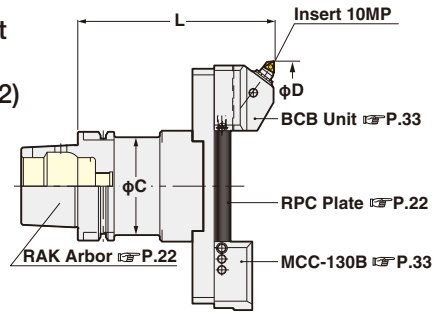

Boring Dia: $\phi 130 \sim 595\text{mm}$

TAPER	Code.No	D		L	C	RAK Arbor Code No.	PPC Plate No	Cartridge (Balancer)	Weight (Kg)	
		MIN.	MAX.							
HSK 63A	HSK 63A-BCB130-215	130	195	215	61	HSK 63A-RAK-130A	RPC-130		6.9	
	-BCB180-215	180	245						7.9	
HSK100A	HSK100A-BCB130-195	130	195	195	90	HSK100A-RAK-110A	RPC-130		9.8	
	-245								245	12.3
	-295								295	15.0
	-345								345	17.7
	-395								395	20.4
	-445								445	23.1
	-495								495	25.8
	-BCB180-195								195	10.2
	-245	245	12.9							
	-295	295	15.6							
	-345	345	18.3							
	-395	395	21.0							
	-445	445	23.7							
	-495	495	26.4							
	-BCB230-195	195	10.9							
	-245	245	13.6							
	-295	295	16.3							
	-345	345	19.0							
	-395	395	21.7							
	-445	445	24.4							
	-495	495	27.1							
	-BCB280-195	195	11.5							
	-245	245	14.2							
	-295	295	16.9							
	-345	345	19.6							
	-395	395	22.3							
	-445	445	25.0							
	-495	495	27.7							
-BCB330-220	330	18.1								
-BCB380-220	380	18.9								
-BCB430-220	430	19.8								
-BCB480-220	480	20.7								
-BCB530-220	530	21.5								

★10MP-T (Cermet) is supplied as standard. P.88 Please refer P.86 for cutting condition.

★MIN. dial readout on dia.: 0.02mm, Sub scale: 0.002mm

★The location of the cutting edge is same as the drive key for standard. The different location is available, please specify θ . e.g. HSK100A-BCB130-245-90°

Up to $\phi 800$ is also available. Please contact with us.

Double Cut Style BCB Boring Bar



BCB-W

★Double cut style can be done with both side of BCB-130 cartridges. Please add "W" at the end of Code No. e.g. HSK100A-BCB130W-195

• True balance cut can be done to adjust the height by micro adjustment first and then to adjust the diameter by adjust screw.

• Stepped cut can be done to change the height of the cartridges.

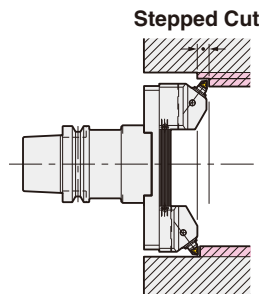

HSK BASE HOLDER for MODULAR TYPE



Fig.1

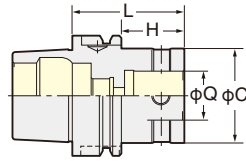

Fig.2

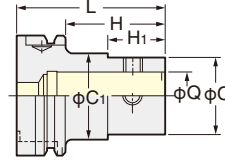
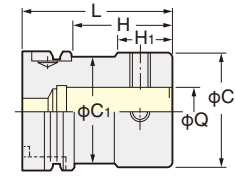

Fig.3



TAPER	Code No.	Q	L	C	C1	H	H1	Coupling Bolt No.	Fig.	Weight(kg)	
HSK 40A	HSK 40A-Q26- 75	26	75	50	33.6	55	40	B26N	3	0.8	
HSK 50A	HSK 50A-Q26- 75	26	75	50	41.6	48	33	B26N	3	1.1	
HSK 63A	HSK 63A-Q 9- 80	9	80	19	30	49	5	B19	2	0.7	
	- 95N		95			64	27			0.7	
	-Q12- 80	12	80	24	35	49	12	B12	2	0.8	
	-110		110			79	50			0.8	
	-Q16- 95	16	95	31	42	64	22	B16	2	1.0	
	-125		125			94	55			1.1	
	-Q20- 80	20	80	40	50	53	27	B20	2	1.4	
	-110		110			83	60			1.3	
	-Q26- 60	26	60	50	—	33	—	B26N	1	1.0	
	- 95		95			68				—	1.5
	-140		140			113				—	2.3
	-Q34- 95	34	95	64	52.4	68	53	B34	3	2.0	
	-110		110			83	68			2.4	
	-Q42- 95	42	95	83	52.4	68	35	B42	3	2.5	
HSK100A	HSK100A-Q 9-110	9	110	19	40	76	5	B19	2	2.3	
	-125N		125			91	27			2.3	
	-Q12- 95	12	95	24	44	61	12	B12	2	2.3	
	-125		125			91	50			2.3	
	-Q16-125N	16	125	31	50	91	22	B16	2	2.8	
	-155		155			121	55			2.9	
	-Q20-110	20	110	40	60	76	27	B20	2	3.0	
	-125		125			91	60			2.9	
	-Q26- 65	26	65	50	65	33	—	B26N	1	2.4	
	-140		140			106	45		2	4.5	
	-170N		170			136	110		4.6		
	-Q34-140	34	140	64	80	106	—	B34	1	4.4	
	-170		170			138	117		2	5.3	
	-200		200			168	147		5.9		
	-Q42-125	42	125	83	—	95	—	B42	1	5.3	
	-190		190			160				7.9	
	-Q42-225A	42	225	83	—	—	—	B42	1	11.7	
	-275A		275							14.4	
-325A	325		17.1								
-375A	375		19.8								

★All base holders have a centre through-tool coolant hole.

★The Coupling screw & wrench are supplied as standard.

★When L length is required longer than standard, please specify the boring depth M.

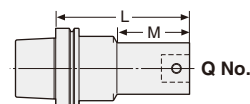

Q No.

HSK DJ BORING BAR

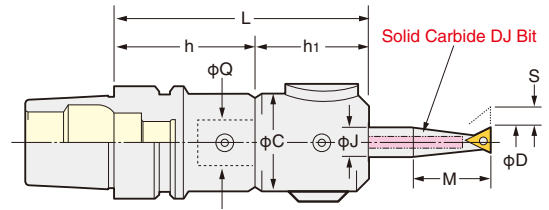

DJ

High Pressure Coolant Through Tool is available.



TAPER	Code No.	Boring Range	Boring Depth	L	C	Bit Hole Size	Shank Code No.	Head Code No.	Bit Stroke	DJ Bit Code No.
		D	M			J				
HSK 63A	HSK 63A-DJ3-100A	3~28	14~80	100	50	10	HSK 63A-Q26-60	Q26-DJ3-40A	5.2	J10
	-135A			135						
	-DJ8-104AN	3~50	14~130	104	59	16	HSK 63A-Q26-60	-DJ8-44AN	6.0	J16
	-139AN			139						
HSK100A	HSK100A-DJ3-105A	3~28	14~80	105	50	10	HSK100A-Q26-65	Q26-DJ3-40A	5.2	J10
	-210A			210						
	-DJ8-109AN	3~50	14~130	109	59	16	HSK100A-Q26-65	-DJ8-44AN	6.0	J16
	-214AN			214						

★MIN. dial readout on dia.: 0.01mm, Sub scale: 0.005mm, 0.8mm/rev.

★Each boxed set of DJ3 and DJ8 Boring Bars include 4 pcs of DJ Boring Bits as standard.

Bits included to HSK63A-DJ8-104A : J16-8-40, J16-18-80, J16-28-85, J16-38-85

Bits included to HSK63A-DJ8-104AN : J16-8-40, J16-18-60, J16-28-65, J16-38-65

★DJ Boring Bar without Boring Bits is also available. Please add“-BD”at the end of Code No. e.g. HSK63A-DJ3-100A-BD

★Shank and DJ Head(including Boring Bits)are delivered in separate packages.

★Please refer P.36 for Boring Bits. Please refer P.87 for cutting condition.

MAJOR DREAM HOLDER

HSK BASE HOLDER for MODULAR TYPE

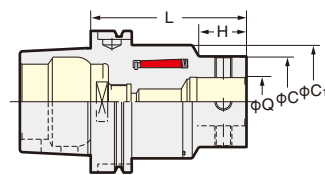

MDQ

Photo shows with spacer and ZMAC-V head.

PAT.

TAPER	Code No.	Q	L	C	C1	H	Weight(kg)	ZMAC-V Boring Range
HSK 50A	HSK 50A-MDQ26-95	26	95	50	50	95.0	1.2	16~70
HSK 63A	HSK 63A-MDQ26-100	26	100	50	52.4	30.0	1.5	16~70
HSK100A	HSK100A-MDQ26-135	26	135	50	80	18.0	5.2	16~70
	-MDQ34-140	34	140	64		27.5	5.3	16~85
	-MDQ42-150	42	150	83		121	6.1	16~180

★All base holders have a centre through coolant hole.

★The coupling bolt and wrench are supplied as standard.

★When L length is required longer than standard, please specify the boring depth M and Q No.

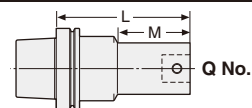

HSK

BASE HOLDER for MODULAR TYPE (POLYGONAL TAPER C6 Shank)



MDQ



Q

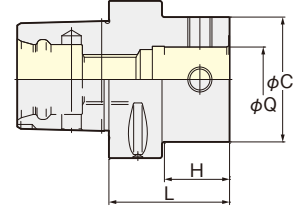
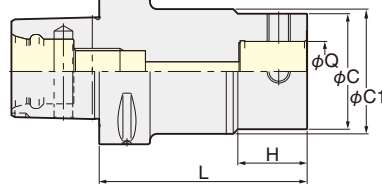

TAPER	Code No.	Q	L	C	C ₁	H	Weight (Kg)	ZMAC-V Boring Range
C6	C6-MDQ26-90	26	90	50	54	30	1.4	16~70

TAPER	Code No.	Q	L	C	H	Weight (Kg)	ZMAC-V Boring Range
C6	C6-Q26-50	26	50	50	27	1.1	16~70
	-Q34-55	34	55	64	33	1.4	16~85

★The coupling screw & wrench are supplied as standard.

MODULAR TYPE BORING HEAD



Modular Type Boring System

Q26 type base holder can be used for various combinations. Ideal for low volume production on manual machine with wide variety of boring sizes.

Spacer & Head

The extensive range of heads & spacers allow the correct selection to suit your boring applications.

Method of Selection for Modular ZMAC-V Boring Arbors

Firstly, select a head, spacer and stepped spacer from boring diameter and depth. Then select base holder and SP26 extension spacer by the length from gauge line.

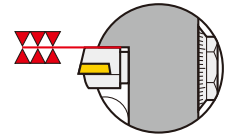

No Micro Vibration due to Double-Contact Support of Cartridge. Long Tool-Life & High Accuracy.

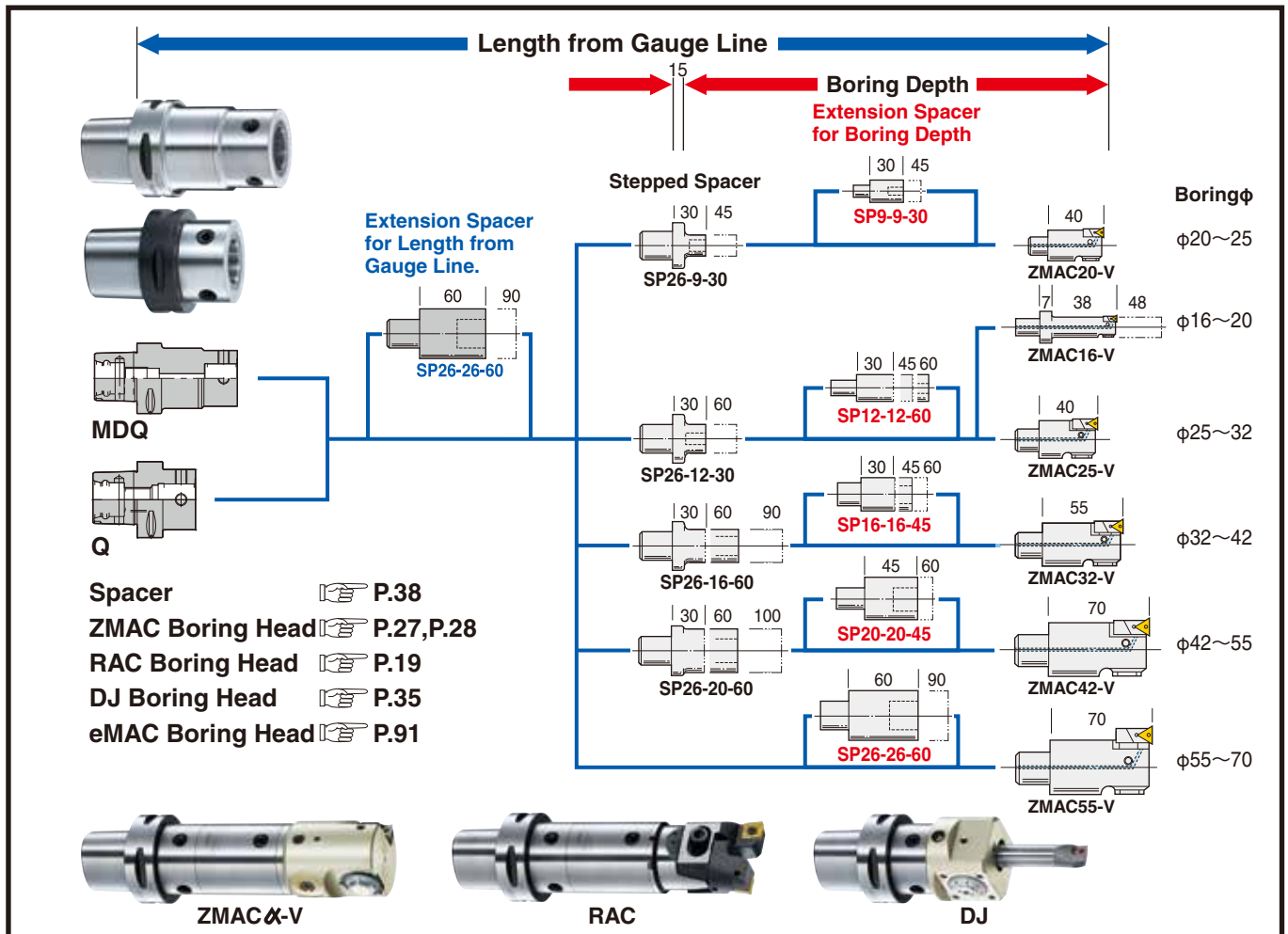

RAC BALANCE-CUT BORING UNIT PARTS LIST

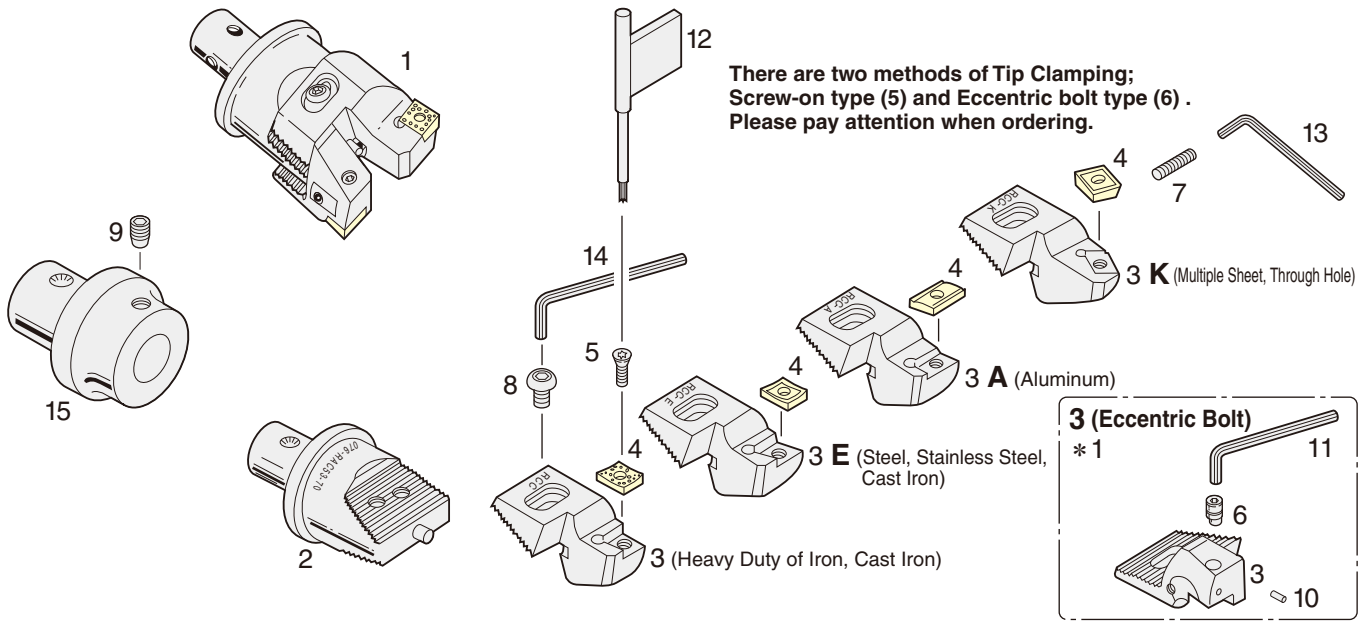

Boring Range	1	2	3	4	5	6	7	8	9	10	11	12	13	14	15			
	RAC Head	RAC Base	Cartridge	Tip	Tip Clamping Bolt	Eccentric Bolt	Adjusting Screw	Cartridge Clamping Bolt	Set Screw	Copper Pin	Tip Clamping L-Wrench	Tip Clamping Handle	L-Wrench for Adjustment	L-Wrench for Cartridge	Stepped Spacer			
φ25~32	12-RAC 25- 55E	12-RAC025- 55B	RCC- 25E	CC07	M3070	—	M508	G025	B12	—	—	T-10	—	—	M3	SP26-12-30		
	- 55A		- 25A	AEG12														
	- 55K		- 25K	SC09														
φ32~45	16-RAC 32- 55E	16-RAC 32- 55B	RCC- 32E	CC08	M4090	—	M512	G032	B16	—	—	T-15	—	—	M4	SP26-16-30		
	- 55A		- 32A	AEG12														
	- 55K		- 32K	SC09	M3070							T-10						
φ43~55	20-RAC 43- 70	20-RAC 43- 70B	RCC- 43	CN08	CSM-70	CSM-43	M514	G043	B20	R12	M3	20S	—	—	M5	SP26-20-30		
	- 70E		- 43E	CC12	M5012	—				—	—	—					—	—
	- 70A		- 43A	AEG16	M4090													
	- 70K		- 43K	SC12	M5012													
φ53~70	26-RAC 53- 70	26-RAC 53- 70B	RCC- 53	CN08	CSM-70	CSM-43	M518	G053	—	R12	M3	20S	M2.5	—	—			
	- 70E		- 53E	CC12	M5012	—				—	—	—				—	—	
	- 70A		- 53A	AEG16	M4090													
	- 70K		- 53K	SC12	M5012													
φ70~100	26-RAC 70- 70	26-RAC 70- 70B	RCC- 70	CN08	CSM-70	CSM-43	M528	G070	—	R12	M3	20S	—	—	M6	—		
	- 70E		- 70E	CC12	M5012	—				—	—	—					—	—
	- 70A		- 70A	AEG16	M4090													
	- 70K		- 70K	SC12	M5012													
	34-RAC 70- 85	34-RAC 70- 85B	RCC- 70	CN08	CSM-70	CSM-43	M528	G070	—	R12	M3	20S	—	—	—			
	- 85E		- 70E	CC12	M5012	—				—	—	—				—	—	
	- 85A		- 70A	AEG16	M4090													
	- 85K		- 70K	SC12	M5012													
φ100~130	42-RAC100-100	42-RAC100-100B	RCC-100	CN08	CSM-70	CSM-43	M538	G070	—	R12	M3	20S	—	—	—			
	-100E		-100E	CC12	M5012	—				—	—	—				—	—	
	-100A		-100A	AEG16	M4090													
	-100K		-100K	SC12	M5012													

★You can use only one type RAC Base irrespective of material and work piece. Suitable Cartridge and Carbide Insert must be selected. ㊦ P.19,P.20

★Insert tip is available as an option.

★There are 2 methods of Tip Clamping; Screw-on type (5) and Eccentric Bolt type (6). Please pay attention when ordering for spare parts.

★Code No. of Cartridge means for Cartridge only. When ordering for cartridge set, please use set Code No. e.g. "S.RCC-25".

★The Code No. of Tip Clamping Handle is unified to T10, T15 and 20S.

★* 1 Eccentric Bolt type Cartridge ; Code No. e.g. "RCC-43Q".

ZMAC ADVANCED BORING UNIT PARTS LIST

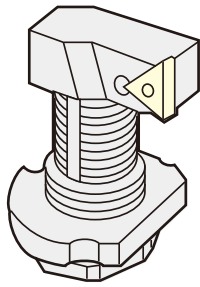

ZMAC-V

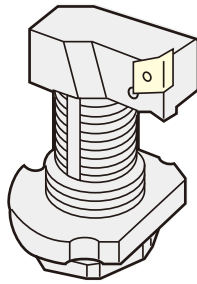

ZMAC-VR

NIKKEN ZMAC-V Boring Heads come complete with the ZMAC-V Boring Unit. Specify the part No. in the table below when ordering spares.

Triangular Insert Heads and Rhomboid Insert Heads use different boring units, cartridges, insert tips, insert clamp bolts, and insert clamp handles, but all other parts are common to both.

Other manufacturers' ISO standard insert tips available on the market may have different insert clamp hole diameters, so please contact us regarding use.

* Boring heads that use ISO standard insert tips available on the market are also available with us.

ZMAC Advanced (ISO) Boring Head
 P.29

* The ZMAC units and new ZMAC-V, ZMAC-VR units are interchangeable.

ZMAC-V Style	Boring Range	Unit	Triangular Insert	Insert Clamp Screw	Insert Clamp Handle	Lock Screw	Adjustment Handle	Unit Clamp Bolt		
ZMAC16 -V	15.9~20.2	M 2HZ- 16V		M2045	T-6	M361	M 2HZL-A	M2045		
ZMAC20 -V	19.8~25.2	M 2HZ- 20V				M362	M 2HZL-B			
ZMAC25 -V	24.8~32.2	M 3HZ- 25V				M363	M 3HZL			
ZMAC32 -V	31.8~42.2	M 4HZ- 32V	4MP-C,B	M2055	T-8	M365	M 4HZL	M2577		
ZMAC42 -V	41.8~55.2	M 5HZ- 42V				M364	M 5HZL			
ZMAC55 -V	54.8~70.2	M 5HZ- 55V	6MP-C,B	M2577 (M2562D) [*]	T-8	M366	M 7HZL	M3090		
ZMAC70 -V	69.8~85.2	M 7HZ- 70V				M360				
ZMAC85 -V	84.8~100.2	M10HZ- 85V				M367			M10HZL	M4012
ZMAC100-V	99.5~140.5	M10HZ-100V				M368				
ZMAC140-V	139.5~180.5	M10HZ-140V				M369				

- ★ Each Unit and Cartridge are supplied without Insert Tip.
- ★ Cartridge for base forming of bore is an option.
Please specify the diameter and width of base forming.
- ★ For Diamond Insert Tip (6MP-D), M2562D* must be used.
- ★ Cartridge can not be supplied alone, please order ZMAC-V unit.



Special cartridge example for necking is available. Please contact us with the work piece drawing.

The cartridge head can be exchanged itself for the head bigger equal to ZMAC42-V.

ZMAC-VR Style	Boring Range	Unit	Triangular Insert	Insert Clamp Screw	Insert Clamp Handle
ZMAC32 -VR	31.8~42.2	M 4HZ- 32VR	CC06-C	M2560	T-8
ZMAC42 -VR	41.8~55.2	M 5HZ- 42VR		M2577	
ZMAC55 -VR	54.8~70.2	M 5HZ- 55VR	CC08-C	M4090	T-15
ZMAC70 -VR	69.8~85.2	M 7HZ- 70VR		M4012	
ZMAC85 -VR	84.8~100.2	M10HZ- 85VR	CC12-C	M5012	T-15
ZMAC100-VR	99.5~140.5	M10HZ-100VR			
ZMAC140-VR	139.5~180.5	M10HZ-140VR			

Boring Range	Cartridge Head		Head Clamp Bolt
41.8~55.2	M 5HZ- 42 CH	M 5HZ- 42RCH	M512C
54.8~70.2	M 7HZ- 70 CH	M 7HZ- 70RCH	
69.8~85.2	M10HZ- 85 CH	M10HZ- 85RCH	
84.8~100.2	M10HZ- 100 CH	M10HZ- 100RCH	
99.5~140.5	M10HZ- 140 CH	M10HZ- 140RCH	

- ★ Each Unit and Cartridge are supplied without Insert Tip.
- ★ Cartridge can not be supplied alone, please order ZMAC-V unit.
- Detach Attach**
 - Loosen head clamp bolt after boring diameter is set to little larger than the MIN. boring diameter.
 - Insert the head into cartridge, then tighten head clamp bolt temporary.
 - Loosen side lock bolt.
 - Rotate the dial ring 0.2~0.3mm to minus direction.
 - Tighten head clamp bolt by pushing the head to the support portion of the main body.

BCB MICRO-CUT BORING UNIT PARTS LIST



BCB Screw on type

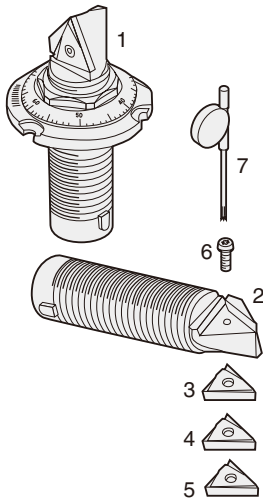

Relation between Micro-Cut Boring Arbor and Micro-Cut Boring Unit

NIKKEN Micro-Cut Boring Arbor is provided with Micro-Cut Boring Unit. When ordering each parts for spare, please place the order by Code No. of Insert, Cartridge and Unit of the following parts list.

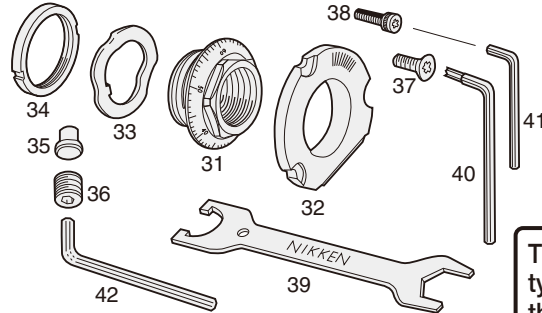

BCB Clamp on type

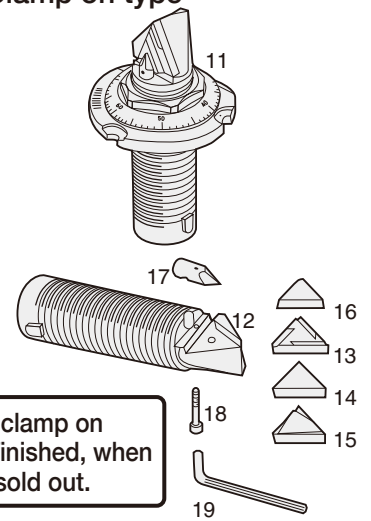

The sales of clamp on type will be finished, when the stock is sold out.

Boring Range	Screw on type							Clamp on type												
	1	2	3	4	5	6	7	11	12	13	14	15	16	17	18	19				
	BCB Unit	Cartridge	Insert for Alloy Steel	Insert for Cast Iron	Insert for Steel, Stainless Steel	Insert Clamp Bolt	Insert Clamp Handle	BCB Unit	Cartridge	Insert for Alloy Steel	Insert for Cast Iron	Insert for Steel, Stainless Steel	Insert Breaker	Clamp Piece	Insert Clamp Bolt	Insert Clamp Handle				
BCB																				
12.7~14.5	M 1-12.7	—	1MP-E	1MP-F	1MP-T	M61	10S	M 1S-2	M 1S-2C*	—	—	—	—	—	—	—				
14.5~19.5	M 1-14.5	—						M 1L-2	M 1L-2C*	—	—	—	—	—	—	—	—	—	—	—
19~22.5	M 2-19	M 2-19 C	3MS-E	3MS-F	3MS-T	M68	13S	M 2S-2	M 2S-2C*	—	—	—	—	—	—	—				
22~29.5	M 2-22	M 2-22 C						M 2L-2	M 2L-2C*	—	—	—	—	—	—	—	—	—	—	—
29~41	M 3-29	M 3-29 C						M 3L-2S	M 3L-2SC	3P-E	3P-F	3P-T	—	CP- 3	B183	M1.5				
38~50	M 5-38	M 5-38 C	6MP-E	6MP-F	6MP-C	M2577	T-8	M 5S-2S	M 5S-2SC	5P-E	5P-F	5P-T	5CB	CP- 5	B185	M2				
48~65	M 5-48	M 5-48 C						M 5L-2S	M 5L-2SC	—	—	—	—	—	—	—	—	—	—	—
62~90	M 7-62	M 7-62 C	10MP-E	10MP-T	10MP-T	M67	20S	M 7L-2S	M 7L-2SC	7P-E	7P-F	7P-T	7CB	CP- 7	B187	M2.5				
82~110	M 7-62	M 7-62 C						M 10L-2S	M 10L-2SC	10P-E	10P-F	10P-T	10CB	CP-10	B180	M3				
100~140	M10-100	M10-100 C						—	—	—	—	—	—	—	—	—	—	—	—	—

★Each Unit and Cartridge are supplied without Insert Tip.
★Codes for BCB boring bars that support micro units are indicated by red text.
e.g. M5-28: **BCB38**

★All brazed types marked * were stopped production on 2007 JAN.
★Each unit and cartridge are supplied without insert tip.
★Brazed type is available for the diameter of φ29~φ200.

Boring Range	31	32	33	34	35	36	37	38	39	40	41	42
	Dial Ring	Lock Flange	Wave Spring	Pre-Load Nut	Lock Metal	Lock Screw	Unit Mounting Bolt A	Unit Mounting Bolt B	Adjustment Handle	Wrench for Unit Mounting Bolt A	Wrench for Unit Mounting Bolt B	Wrench for Lock Screw
12.7~14.5	B311	B321	B331	B341	B351	B361	—	B381	M391	—	M1.27	M1.5
14.5~19.5	B312	B322	9M216W	9M216P	B352	B362	—	B382	M392	—	T6	M2
19~22.5						M363						
22~29.5	B313	B323	M333	9M325P	B353	B363	—	B384	M393	—	13S	M2.5
29~41						M363						
38~50	B315	B325	M335	9M542P	B355	B365	—	B386	M395	—	20S	M3
48~65		B326				B366						
62~90	B317	B327	M337	9M770P	B357	B367	—	B387	M397	M407	M405	M5
82~110						B368						
100~140	B310	B320	M330	9M108P	B350	B360	M370	—	M390	M400	—	M6

★31, 32, 33 and 34 are set for spare parts. When ordering, please add "D." at the beginning of Code No.
e.g. D.M2-22 for Boring Range: 22~29.5mm

RAC BALANCE-CUT BORING ARBOR CUTTING DATA



CC (Positive type) RAC-E



CN (Negative type) RAC



RAC-A



RAC-K



Material

Steel	60~150m/mim. (Dry or Wet cutting)
Stainless Steel	40~80m/mim. (Wet cutting)
Cast Iron	60~150m/mim. (Dry or Wet cutting)
Aluminium, Non-ferrous metal	200~500m/mim. (Wet cutting)
Multiple Sheets, Through Hole	40~120m/mim. (Dry or Wet cutting)

Recommended cutting Speed

◎...Best ○...Good ---...Unsuitable

Insert		SS41	S55C	SCM	SKD	SC	FC,FCD	SUS	AL,ALC	Interrupted Cutting
Code No.	Grade									
CC	Coated Carbide M	◎60~120	◎60~150	◎60~150	◎50~80	○80~120	○60~150	◎40~80	—	○
	Coated Carbide K	—	—	—	—	◎80~120	◎60~150	—	—	—
CN	Coated Carbide M	○60~120	○60~150	○60~150	○50~80	○50~80	○60~150	○40~80	—	○
AEG	K10	—	—	—	—	—	—	◎400~800	—	○
SC	Coated Carbide M	◎60~120	◎60~150	◎60~150	◎50~80	○80~120	○60~150	◎40~80	—	○
	Coated Carbide K	—	—	—	—	◎80~120	◎60~150	—	—	—

- ★The cutting speed is recommended to be reduced to 50% for the interrupted cutting.
- ★When L/D is longer, the insert tip with small Nose R is recommended.
- ★When L/D is longer, the feed rate at the entrance is recommended to be reduced to 60 to 70%.

Relation between Boring Dia. & MAX. Removal

MAX. Removal on Dia. (mm)

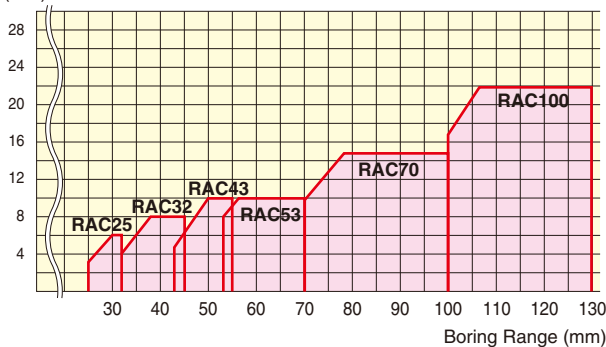

Recommended Cutting Condition (removal, feed)

These figures are based on the application of L/D=3~3.5 times on cast iron.

Boring Range	Type	Best Condition		MAX. Condition	
		Removal mm/φ	Feed mm/rev.	Removal mm/φ	Feed mm/rev.
φ25~ 32	RAC 25	2.0~ 4.0	0.2~0.3	0.5~ 6.0	0.1~0.4
32~ 43	RAC 32	3.0~ 5.0	0.2~0.3	1.0~ 8.0	0.1~0.4
43~ 53	RAC 43	4.0~ 7.0	0.2~0.3	1.0~10.0	0.1~0.5
53~ 70	RAC 53	4.0~ 7.0	0.2~0.3	1.0~10.0	0.1~0.5
70~100	RAC 70	5.0~10.0	0.3~0.4	1.0~15.0	0.1~0.5
100~130	RAC100	7.0~12.0	0.3~0.4	1.0~22.0	0.1~0.5

ZMAC ADVANCED BORING SYSTEM CUTTING DATA **NIKKEN**

Selection of Insert Tip for each material.

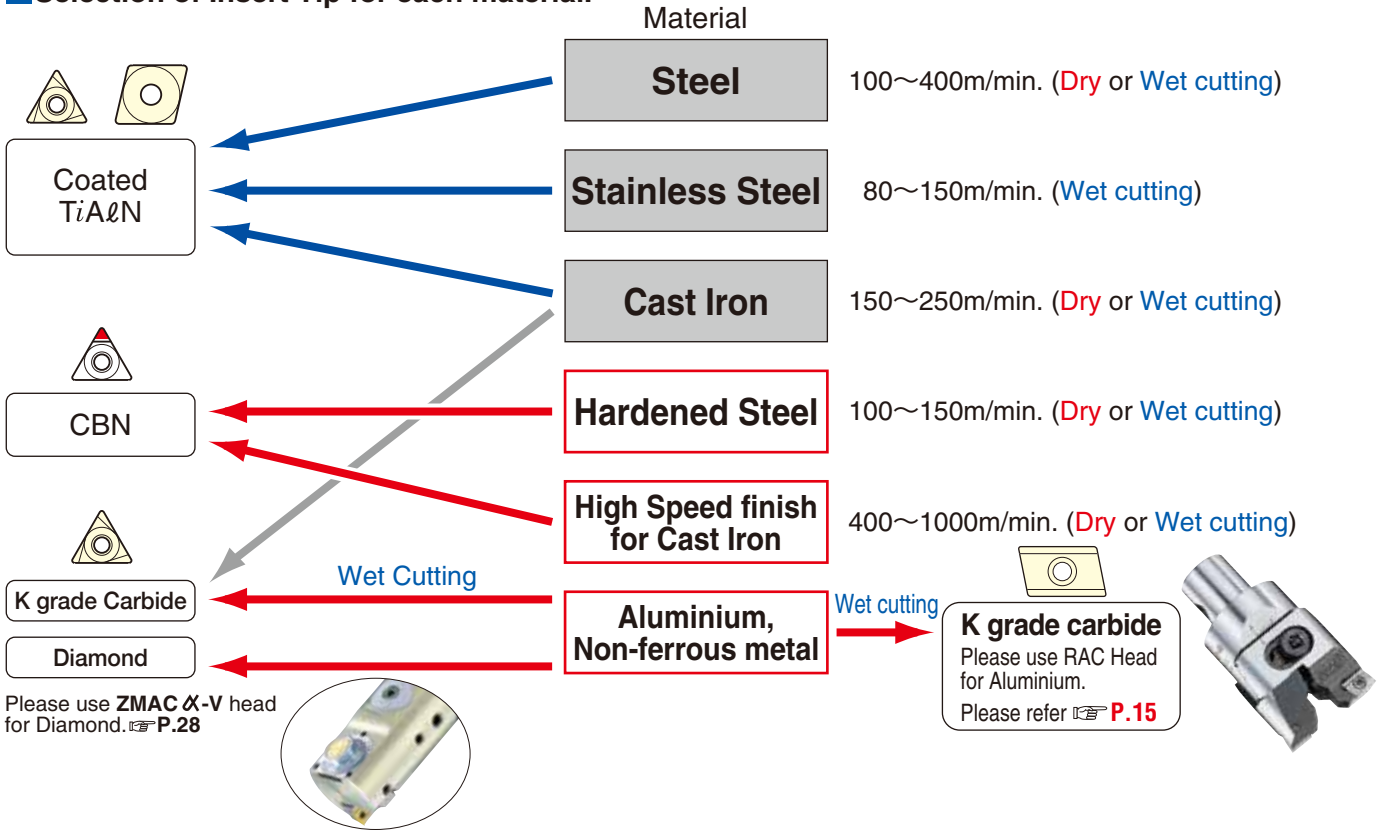

Recommended cutting Speed ○...Best ○...Good ---Unsuitable

Insert	Code No.	Grade	SS41	S55C	SCM	SKD	SC	FC,FCD	SUS	AL,ALC	Hardened Steel			Interrupted Cutting
											SCM	SKD	SUJ	
	C	Coated	○	○	○	○	○	○	○	-	-	-	-	○
	E	P10	○	○	○	○	○	-	○	-	-	-	-	○
	F	K10	-	-	-	-	-	○	-	○	-	-	-	○
	T	Cermet	○	○	○	○	○	-	○	-	-	-	-	○
	B	CBN	-	-	-	-	-	○	-	-	○	○	○	○
	D	Diamond	-	-	-	-	-	-	-	○	○	-	-	-
	C	Coated Carbide M	○	○	○	○	○	○	○	-	-	-	-	○
		Coated Carbide K	○	○	○	○	○	○	○	-	-	-	-	○

- ★ Existing Inserts (Cermet, P grade Carbide & K grade Carbide) are available.
- ★ The cutting speed is recommended to be reduced to 50% for the interrupted cutting.
- ★ When L/D is longer, the insert tip with small Nose R is recommended.
- ★ When L/D is longer, the feed rate at the entrance is recommended to be reduced to 60 to 70%.

Recommended Cutting Condition (removal, feed)

Boring Range	Type								
		Best Condition		MAX. Condition		Best Condition		MAX. Condition	
		Removal mm/φ	Feed mm/rev.	Removal mm/φ	Feed mm/rev.	Removal mm/φ	Feed mm/rev.	Removal mm/φ	Feed mm/rev.
φ16~20	ZMAC16-V	0.2~0.4	0.05~0.07	1.0	0.1				
φ20~25	ZMAC20-V	0.2~0.4	0.05~0.07	1.5	0.1				
φ25~32	ZMAC25-V	0.2~0.4	0.05~0.07	2.0	0.1				
φ32~42	ZMAC32-V	0.2~0.4	0.05~0.08	2.0	0.2	1.0~3.0	0.1~0.15	5.0	0.2
φ42~55	ZMAC42-V	0.2~0.5	0.05~0.08	4.0	0.2	1.0~3.0	0.1~0.15	5.0	0.2
φ55~70	ZMAC55-V	0.2~0.5	0.05~0.08	4.0	0.2	1.0~3.0	0.1~0.15	5.0	0.2
φ70~85	ZMAC70-V	0.2~0.8	0.05~0.1	4.0	0.25	1.0~4.0	0.1~0.2	8.0	0.25
φ85~	ZMAC85-V~	0.2~0.8	0.05~0.1	4.0	0.25	1.0~4.0	0.1~0.2	8.0	0.25

In case of CBN insert, reduce L/D as small as possible : MAX. 3 times.
Stock removal on diameter.
D<32mm : less than 0.25mm
D>32mm : less than 0.3mm

Feed per rev. depends on Nose/R and accuracy required.
Logical Surface Finish : $\frac{(\text{Feed per rev.})^2}{8 \times \text{Nose/R}}$

PARTS LIST
INSERT TIP

DJ BORING ARBOR CUTTING DATA



Selection of Insert Tip for each material.

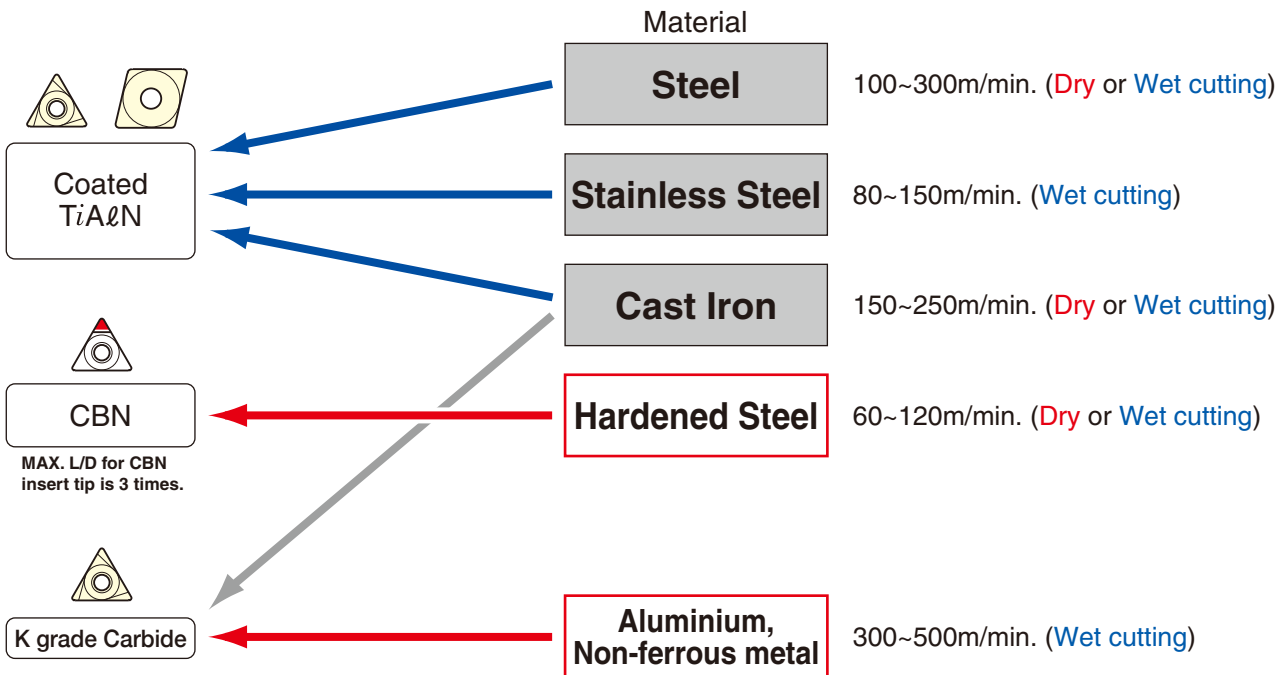

Recommended cutting Speed

○...Best ○...Good -...Unsuitable

Insert	Code No.	Grade	SS41	S55C	SCM	SKD	SC	FC,FCD	SUS	AL,ALC	Hardened Steel			Interrupted Cutting
											SCM	SKD	SUJ	
	C	Coated	○	○	○	○	○	○	○	-	-	-	-	○
	E	P10	○	○	○	○	○	-	○	-	-	-	-	○
	F	K10	-	-	-	-	-	○	-	○	-	-	-	○
	T	Cermet	○	○	○	○	○	-	○	-	-	-	-	○
	B	CBN	-	-	-	-	-	-	○	-	-	○	○	○
	C	Coated	○	○	○	○	○	○	○	-	-	-	-	○

★Existing Inserts (Cermet,P grade Carbide & K grade Carbide) are available.
 ★The cutting speed is recommended to be reduced to 50% for the interrupted cutting.

Recommended Cutting Condition (removal,feed)

Boring Range	Type		Best Condition		MAX. Condition	
	DJ3	DJ8	mm/φ	mm/rev.	mm/φ	mm/rev.
φ 3~ 8	J10- 3		~0.1	0.03~0.07		
φ 5~ 15	J10- 5		0.1~0.2	0.05~0.07		
φ 8~ 18	J10- 8	J16- 8	0.1~0.2	0.05~0.08	1.0	0.1
φ18~ 28	J10-18	J16-18	0.2~0.4	0.05~0.08	1.5	0.15
φ28~ 39		J16-28	0.2~0.4	0.05~0.08	2.0	0.15
φ38~ 50		J16-38	0.2~0.5	0.05~0.08		

In case of CBN insert, reduce L/D as small as possible : MAX. 3 times.
 Stock removal on diameter.
 D<32mm : less than 0.25mm
 D>32mm : less than 0.3mm

Feed per rev. depends on Nose/R and accuracy required.
 Logical Surface Finish : $\frac{(\text{Feed per rev.})^2}{8 \times \text{Nose/R}}$

Example of hardened steel boring with CBN Insert

Reduce L/D as small as possible:MAX. 3times
 For bits of L/D shorter than standard one are also available. Please contact with us.

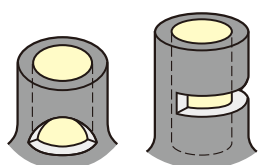

Example of intermittent boring of hardened steel (HRC60) φ10mm

Results of concentricity on 24 pcs. were all within 3μm.

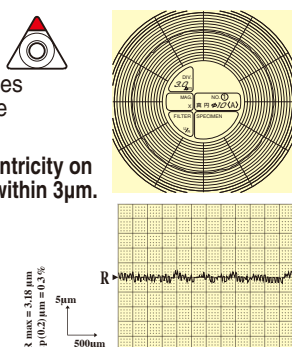

Results of surface finish on 24 pcs. were all within 3.3 microns. (R MAX.)

Results of concentricity on 24 pcs. were all within 3.6μm.

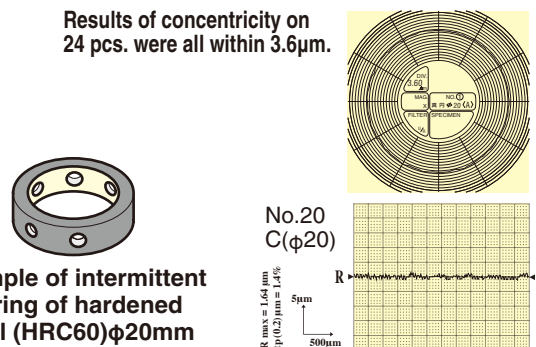

Example of intermittent boring of hardened steel (HRC60)φ20mm

Results of surface finish on 24 pcs. were all within 2.8 microns. (R MAX.)

NIKKEN INSERT TIP (EXCLUSIVE FOR BORING ARBOR) (1)



Material	Steel	●	●	●				
	Stainless Steel	●	●					
	Cast Iron	●			●	●		
	Aluminium					●		
	High Speed finish for Cast Iron						●	
	Hardened Steel						●	
	High Speed finish for Aluminium							●

For the Boring of Large Diameter and Short Depth, the use of insert with large nose radius is recommended. The smaller nose radius inserts are ideal for smaller diameter boring or finishing operation.

Applicable Arbor	Dimension	Code No.	Material NOSE R	Coated Cermet	Cermet (w/o coating)	Carbide P	Carbide K	CBN	Diamond		
				Grade	C	T	E	F-NB*2 w/o breaker	F	B	D
				Material	PV90	T2000Z	NS530*5	TN90	ST10P	H1	KBN10B*6
BCB12.7, BCB14.5		1MP-○2	0.2	●		●		●			
			0.4								
BCB19, BCB22, BCB29		3MS-○2	0.2	●		●	●*2	●	●		
			0.4								
ZMAC16-V, ZMAC20-V, ZMAC25-V for DJ Bit		3MP-○2	0.2		●		●*2	●	●		
			0.4		●				●	●	
ZMAC32-V		4MP-○2	0.2		●		●*2	●	●		
			0.4		●			●*2	●	●	
ZMAC42-V-ZMAC140-V, BCB38, BCB48, DJ Bit, MCCZ130-V, BAC130-V - BAC530-V		6MP-○2	0.2	●	●		●*2	●	●*4		
			0.4	●	●		●*2	●	●	●*4	
			0.8	●	●		●*2	●	●	●*4	
BCB62, BCB82, BCB100		10MP-○2	0.2	●			●*2	●			
			0.4	●			●*2	●	●		
			0.8	●			●*2	●	●		

- ★Minimum quantity of CBN and Diamond: 1pcs, All other insert tip: 10pcs
- ★*2 "-NB" (w/o breaker) is recommended for cast iron.
- ★*3 Hole diameter of 6MP is φ2.8mm. M2562D (Optional tip clamp bolt) is required for the ISO standard insert tip with the hole diameter of φ3.3~φ3.5mm.
- ★*4 M2562D is necessary for 6MP-D (Diamond), because of the hole diameter is different.
- ★The ISO code No. surrounded with () is the Nikken original insert tip.
- ★*5 Changes it to NS9530 sequentially as soon as stock disappears.
- ★*6 Changes it to KBN510 sequentially as soon as stock disappears.

Please add the grade indication into ○, and add the insert tip material indication at the end off the Code No.
e.g. 6MP-C4 (PV90), 6MP-F4-NB (H1)

Code No. of ISO standard Insert Tip

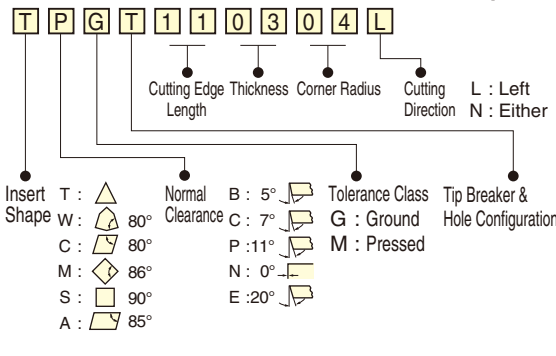

PARTS LIST INSERT TIP

NIKKEN INSERT TIP (EXCLUSIVE FOR BORING ARBOR) (2)



Material	Steel	●	●	
	Stainless Steel	●	●	
	Cast Iron	●	●	●

For the Boring of Large Diameter and Short Depth, the use of insert with large nose radius is recommended. The smaller nose radius inserts are ideal for smaller diameter boring or finishing operation.

Applicable Arbor	Dimension	Code No.	NOSE R	Coated Cermet	Coated Carbide M	Coated Carbide K
				Grade	PV90	AC630M
J10-5, J16-5		CC03-○2	0.2	●		
ZMAC32-VR, ZMAC42-VR ZMAC55-VR		CC06-○4	0.4		●	●
		CC06-○8	0.8		●	●
RAC25E		CC07-○4	0.4		●	●
		CC07-○8	0.8		●	●
ZMAC70-VR, ZMAC85-VR, RAC25E (CC08), RAC32E		CC08-○4	0.4		●	●
		CC08-○8	0.8		●	●
RAC43 - RAC530 (Eccentric Bolt Type)		CN08-○8	0.8		●	
ZMAC100-VR, ZMAC140-VR RAC43E - RAC100E		CC12-○4	0.4		●	●
		CC12-○8	0.8		●	●

★Minimum quantity of CBN and Diamond: 1pcs, All other insert tip: 10pcs
★The ISO code No. surrounded with () is the Nikken original insert tip.

Please add the grade indication into ○, and add the insert tip material indication at the end off the Code No.
e.g. 6MP-C4 (PV90) , 6MP-F4-NB (H1)

Code No. of ISO standard Insert Tip

T P G T 1 1 0 3 0 4 L

Cutting Edge Length Thickness Corner Radius Cutting Direction L : Left
N : Either

Insert Shape	T :	Normal Clearance	B : 5°	Tolerance Class	Tip Breaker & Hole Configuration	W :
	W :		C : 7°	G : Ground	T :	
	C :		P : 11°	M : Pressed	R :	
	M :		N : 0°		B :	
	S :		E : 20°		H :	
	A :				M :	
					X : Special	

NIKKEN INSERT TIP (EXCLUSIVE FOR BORING ARBOR) (3)



Material	Steel	●	●			
	Stainless Steel	●				
	Cast Iron			●		
	Aluminium			●		
	High Speed finish for Cast Iron				●	
	Hardened Steel				●	
		Cermet (w/o coating)	Carbide P	Carbide K	CBN	
		Grade	T	E	F	B
		Material NOSE R	T12A	ST10P	HTi10	KBN10B*1
Applicable Arbor	Dimension	Code No.				
BCB29		3P-○2	0.2	●	●	●
BCB38, BCB48		5P-○4	0.4	●	●	●
BCB62, BCB82		7P-○4	0.4	●	●	●
		7P-○8	0.8		●	●
BCB100		10P-○4	0.4	●	●	●
		10P-○8	0.8		●	●

★Minimum quantity of CBN: 1pcs, All other insert tip: 10pcs ★*1 Changes it to **KBN510** sequentially as soon as stock disappears.
★The ISO code No. surrounded with () is the Nikken original insert tip.

Please add the grade indication into ○, and add the insert tip material indication at the end off the Code No. e.g. 10P-T4 (T12A)

Grade & Material

Grade	Grade Indication	Insert Tip Material Indication	Specification
Coated Cermet	C	PV90	Applicable for the midium roughing and finishing on the steel. Very stable cutting with coolant to be improved the heat resistance and the impact resistance.
		T2000Z	ZX coated suitable for the high speed finishing on the steel with long insert life. Very fine surface finish to be improved the impact resistance and the fracture resistance.
Coated Carbide M		AC630M	Very tough carbide M (base material) with the super FF coated. Excellent for the impact resistance and the fracture resistance for the stainless steel
Coated Carbide K		AC410K	Very tough carbide K (base material) with the super FF coated. Very stable cutting for the ductile cast iron and normal cast iron.
Cermet (w/o coating)	T	NS530	The general material for the steel and the cast iron with the heat resistance and the toughness.
		NS9530	New grade with tough and smooth top layer demonstrates amazing fracture resistance. Stable tool life due to incredible toughness. This is an upgraded version of NS530.
		T12A	Applicable for the roughing and finishing on the steel. Very stable cutting to be improved the heat resistance and the impact resistance.
Carbide P	E	ST10P	Applicable for the middle to high speed cutting on the steel and the steel casting.
Carbide K	F	H1	Excellent wear resistance and applicable for the cast iron, non-ferrous metal and the non-metal.
		HTi10	Toughness and the excellent wear resistance. Applicable for the cast iron, non-ferrous metal and the non-metal.
		KW10	Stable wear resistance and the fracture resistance. Applicable for the cast iron, non-ferrous metal and the non-metal.K10
CBN	B	KBN10B	Excellent for the fracture resistance and wear resistance. Suitable for the high performance and high accuracy cutting on the harden steel
		KBN510B	Excellent for the fracture resistance and wear resistance. This is an upgraded version of KBN10B. Suitable for the high performance and high accuracy cutting on the harden steel.
Diamond	D	KPD010	Suitable for the high speed cutting on the aluminium and the non-metal. Applicable for the cutting on the carbide, ceramics, glass fibere and the plastic also.

MODULAR TYPE eMAC BORING HEAD

NIKKEN

NEW



eMAC $\phi 6 \sim \phi 110$

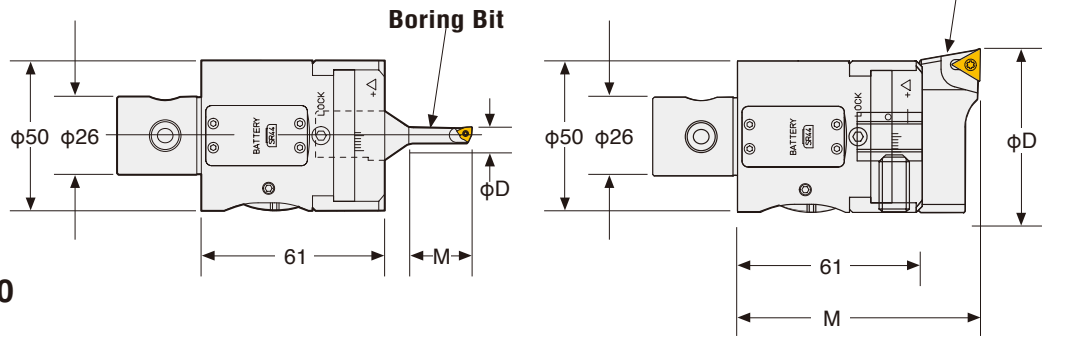

Q No.	Boring Head Code No.	Boring Range	Boring Depth	Boring Bit	Solid Boring Bit	Cartridge
		ϕD	M			
Q26	Q26-EMAC6110-61	$\phi 6 \sim \phi 110$	21~(94) * Please refer to the layout below	EJ16- 6-21	EJX16- 6- 45	ECC-28- 10 -36-11.5 -54- 19
				- 8-28	- 8- 60	
				-10-35	-10- 75	
				-11-40	—	
				-12-42	-12- 90	
				-14-50	-14-105	
				-16-50	-16-120	
				-18-63	—	
				-22-68	—	

★Please refer to P.93 for Shank and P.38 for Spacer.
 ★Centre Through Tool Coolant function is available as standard.(MAX.4MPa)
 ★Please refer to P.95 for Boring Bit, Cartridge and Insert Tip.

COMBINATION OF PROCESSING EACH DIAMETER

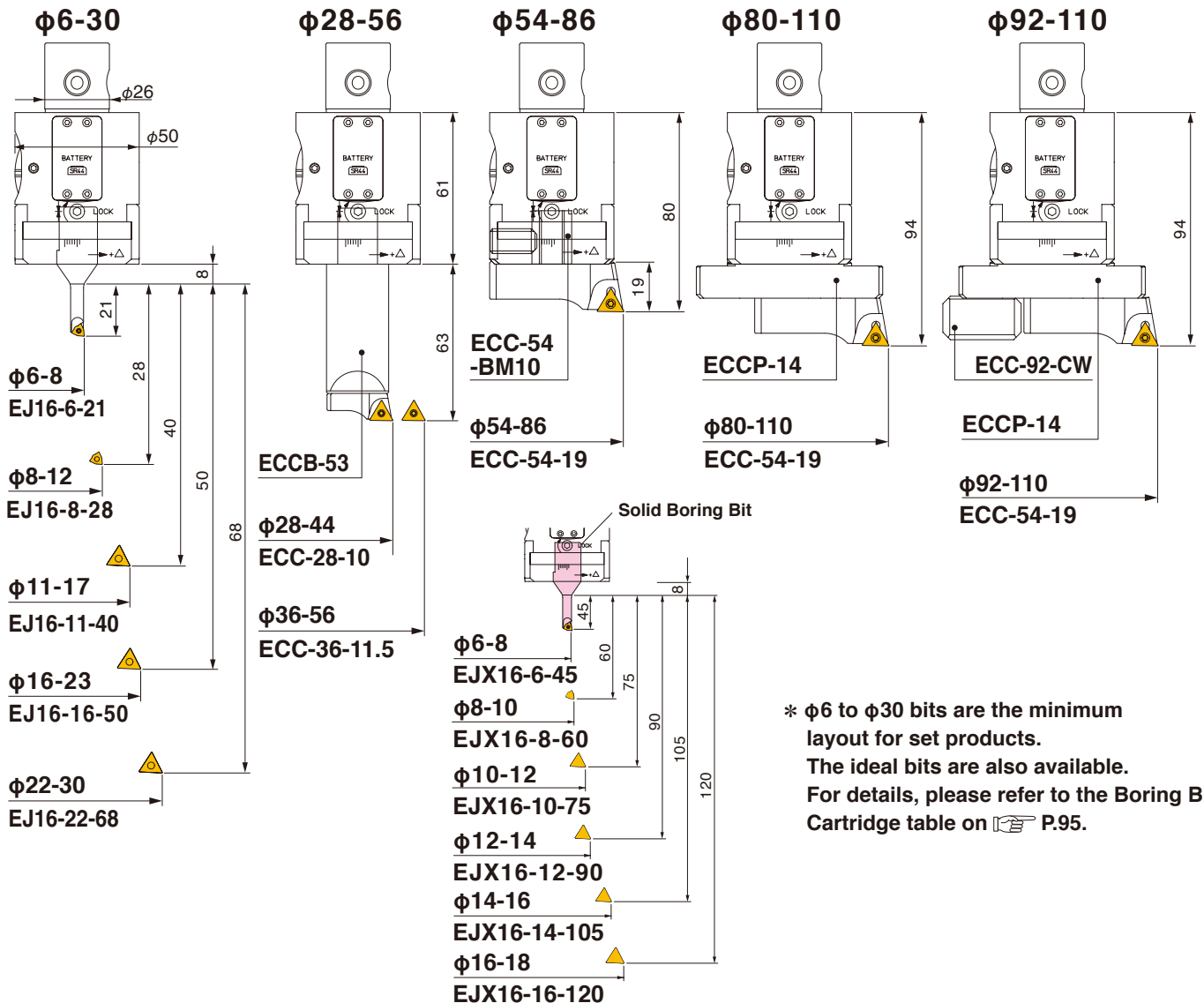

MODULAR TYPE eMAC-W BORING HEAD



NEW



eMAC-W $\phi 6 \sim \phi 200$

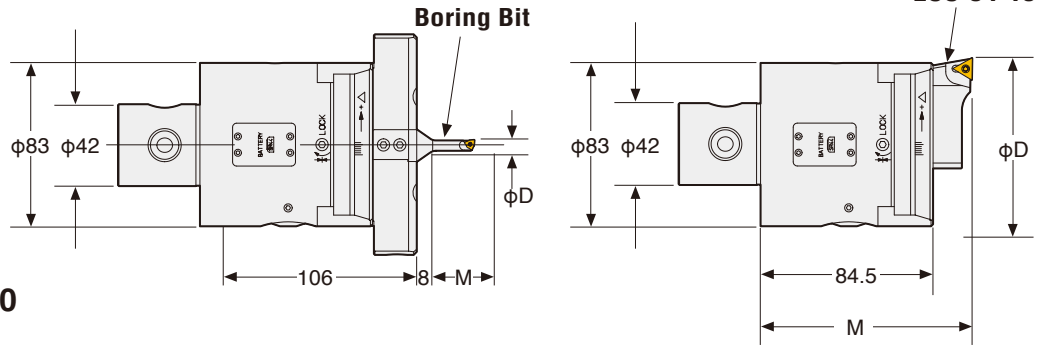

Q No.	Boring Head Code No.	Boring Range	Boring Depth	Boring Bit	Solid Boring Bit	Cartridge
		ϕD	M			
Q42	Q42-EMAC6200W-85	$\phi 6 \sim \phi 200$	21~(125.5) * Please refer to the layout below	EJ16- 6-21	EJX16- 6- 45	ECC-28- 10 -36-11.5 -54- 19
				- 8-28	- 8- 60	
				-10-35	-10- 75	
				-11-40	—	
				-12-42	-12- 90	
				-14-50	-14-105	
				-16-50	-16-120	
				-18-63	—	
				-22-68	—	

★Please refer to P.94 for Shank and P.38 for Spacer.
 ★Centre Through Tool Coolant function is available as standard.(MAX.4MPa)
 ★Please refer to P.95 for Boring Bit, Cartridge and Insert Tip.

COMBINATION OF PROCESSING EACH DIAMETER

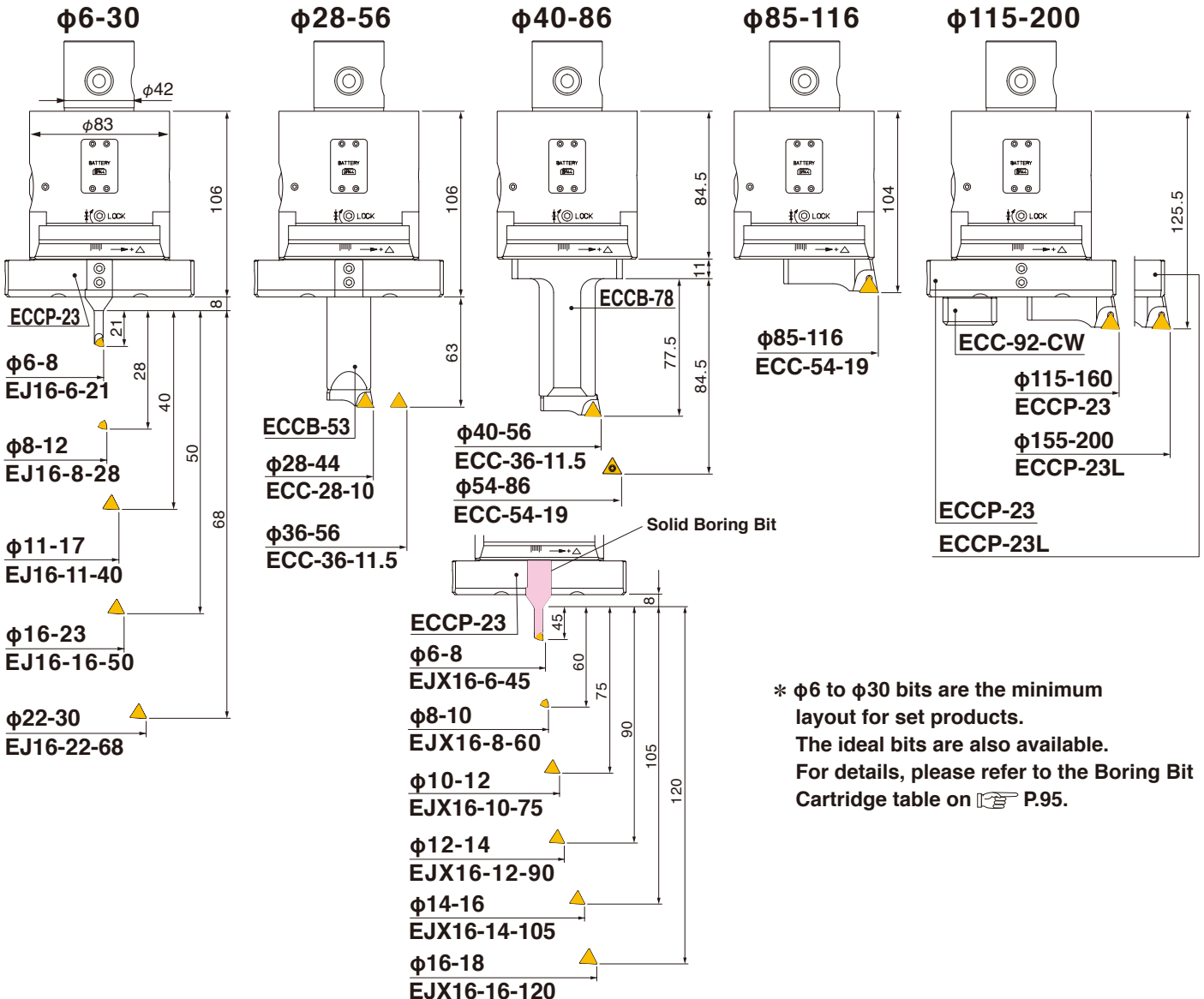

eMAC

BASE HOLDER for eMAC (Q26)



Q26 Base Holder

Shank	Code No.	Coupling Dia. Q	L	C	C1	H	H1	Coupling Bolt No.	Fig.	Weight(Kg)			
BT	BT30 -Q26- 40	26	40	50	45	18	6	B26	3	0.5			
	BT40 -Q26- 50		50		-	20	-	B26N	1	1.1			
	- 95		95			65				1.8			
	-140		140			110				2.4			
	BT50 -Q26- 65		65		65	27	-	B26N	2	3.7			
	-140		140			47				5.3			
	-170N		170			112				5.4			
2LOCK NBT	NBT30 -Q26- 40	26	40	50	45	18	6	B26	3	0.5			
	NBT40 -Q26- 50		50		-	20	-	B26N	1	1.1			
	- 95		95			65				1.8			
	-140		140			110				2.4			
	NBT50 -Q26- 65		65		65	27	-	B26N	2	3.7			
	-140		140			47				5.3			
	-170N		170			112				5.4			
3LOCK MBT	MBT40 -Q26- 50	26	50	50	-	20	-	B26N	1	1.1			
	- 95		95			65				1.8			
	-140		140			110				2.4			
	MBT50 -Q26- 65		65		65	27			-	B26N	2	3.7	
	-140		140			47						5.3	
	-170N		170			112						5.4	
NC5	NC5- 46 -Q26- 40	26	40	50	45	18	6	B26	6	0.4			
	NC5- 63 -Q26- 50		50			-	20			-	B26N	4	0.9
	- 95		95				65						1.5
	-140		140				110						2.3
	NC5- 85 -Q26- 65		65		65	27	-	B26N	5	2.5			
	-140		140			102				40	4.6		
	-170		170			132				110	4.7		
	NC5-100 -Q26- 65		65		65	27	-	B26N	4	3.6			
	-140		140			97				45	5.7		
	-170		170			127				110	5.8		
HSK-A	HSK40A -Q26- 75	26	75	50	33.6	55	40	B26N	6	0.8			
	HSK50A -Q26- 75		75		41.6	48	33			1.1			
	HSK63A -Q26- 60		60		-	33	-		B26N	4	1.0		
	- 95		95			68					1.5		
	-140		140			113					2.3		
	HSK100A-Q26- 65		65		65	33	-		B26N	5	2.4		
	-140		140			106					45	4.5	
	-170N		170			136					110	4.6	
POLYGONAL TAPER	C6 -Q26- 50	26	50	50	-	27	-	B26N	4	1.1			
	C8 -Q26- 60		60			29				2.0			
NT	T30W -Q26- 40	26	40	50	-	-	-	B26	7	0.6			
	T40U -Q26- 35		35		-	-	-	B26N		1.1			
	T40M -Q26- 35		35		-	-	-			1.1			
	T50U -Q26- 45		45		-	-	-			3.3			
	T50M -Q26- 45		45		-	-	-	3.3					
HA	TT35 -Q26- 35	26	35	50	-	-	-	B26	8	0.7			
	TT45 -Q26- 45		45		-	-	-			1.8			
MT	MT3T -Q26- 45	26	45	50	-	-	-	B26N	9	0.8			
	MT4T -Q26- 45		45		-	-	-			1.1			
	MT5T -Q26- 35		35		-	-	-			1.9			
	MT6T -Q26- 60		60		-	-	-			5.1			
K	K32 -Q26- 40	26	40	50	-	-	-	B26N	10	0.8			
	K42 -Q26- 40		40		-	-	-			1.3			

★All base holders have a centre through-tool coolant hole. ★The Coupling screw & wrench are supplied as standard.

★Shanks not noted above can also be supported. Please contact us for more details.

BASE HOLDER for eMAC-W (Q42)



Q42 Base Holder

Shank	Code No.	Coupling Dia. Q	L	C	C1	H	H1	Coupling Bolt No.	Fig.	Weight(Kg)
BT	BT40 -Q42- 95	42	95	83	62	68	55	B42	3	2.8
	BT50 -Q42- 125		125		-	87	1		6.5	
	- 190		190		-	152			9.1	
	-225A		225		98	-	-		11	12.9
	-275A		275							15.6
	-325A		325							18.3
	-375A		375							21
2LOCK NBT	NBT40 -Q42- 95	42	95	83	62	68	55	B42	3	2.8
	NBT50 -Q42- 125		125		-	87	1		6.5	
	- 190		190		-	152			9.1	
	-225A		225		98	-	-		11	12.9
	-275A		275							15.6
	-325A		325							18.3
	-375A		375							21
3LOCK MBT	MBT40 -Q42- 95	42	95	83	62	68	55	B42	3	2.8
	MBT50 -Q42- 125		125		-	87	1		6.5	
	- 190		190		-	152			9.1	
NC5	NC5- 63 -Q42- 95	42	95	83	62	68	55	B42	3	3.6
	NC5-100 -Q42- 125		125		-	87	1		6.5	
	- 190		190		-	152			9.1	
HSK-A	HSK63A -Q42- 95	42	95	83	52.4	68	35	B42	3	2.5
	HSK100A-Q42- 125		125		-	69	1		5.3	
	- 190		190		-	161			7.9	
	-225A		225		-	-	-		11	11.7
	-275A		275							14.4
	-325A		325							17.1
	-375A		375							19.8
NT	NT50U -Q42- 95	42	95	83	-	-	-	B42	7	5.8
	NT50M -Q42- 95		95		-	-	-		5.8	
MT	NT6T -Q42- 60	42	60	83	-	-	-	B42	9	6.1

★All base holders have a centre through-tool coolant hole. ★The Coupling screw & wrench are supplied as standard.

★Shanks not noted above can also be supported. Please contact us for more details.

★Base Holder for POLYGONAL TAPER C6, C8 : Please contact with us.

Dimension

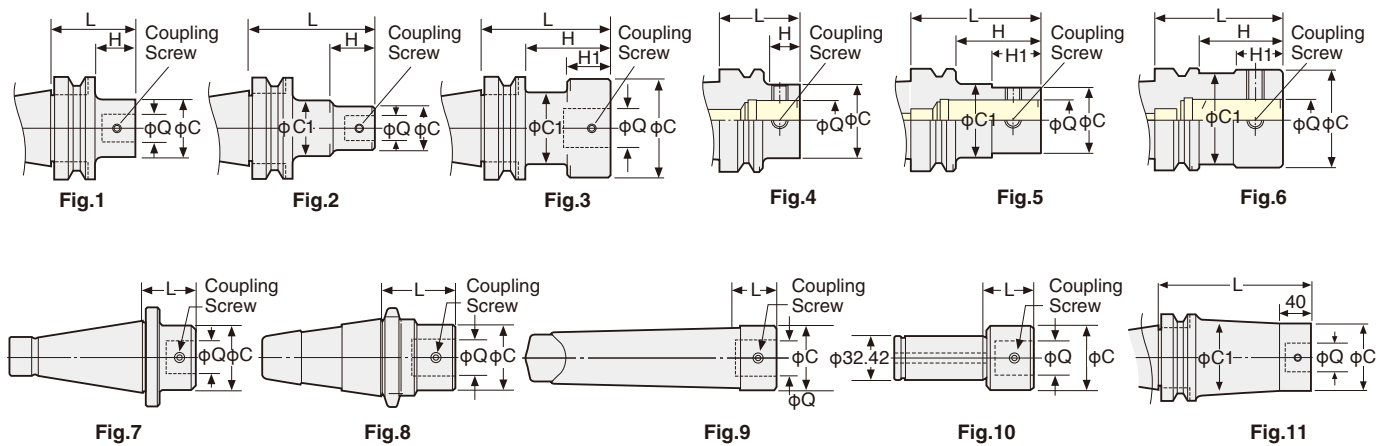

BORING BIT & CARTRIDGE for eMAC BORING SYSTEM



eMAC Boring Head & eMAC-W Boring Head



Q26-EMAC6110-61



Q42-EMAC6200W-85

* Select the ideal bit, cartridge, and insert tip based on the boring head and the equipment conditions

Boring Bit & Cartridge *Each Boring bit and Cartridge are supplied without insert tip.

Boring Range Φ	Boring bit	Solid carbide bit	Cartridge	Insert tip		Clamp bolt		Torx Wrench	
							Thread size		
6 - 8	EJ16- 6-21	EJX16- 6- 45	-	EM02	-	TS21	M2	T-6	
8 - 10	EJ16- 8-28	EJX16- 8- 60		TS211					
10 - 12	EJ16-10-35	EJX16-10- 75		-	-	EM09	CS250T	M2.5	T-8
11 - 13	EJ16-11-40	-							
12 - 14	EJ16-12-42	EJX16-12- 90							
14 - 16	EJ16-14-50	EJX16-14-105							
16 - 18	EJ16-16-50	EJX16-16-120							
18 - 22	EJ16-18-63	-							
22 - 30	EJ16-22-68	-	-	-	EM09	CS250T	M2.5	T-8	
28 - 44	-	-							ECC-28-10
36 - 56	-	-							ECC-36-11.5
54 - 200	-	-	ECC-54-19	-	EM11	CS300890T	M3	T-8	

★The EJ16-10-35, EJ16-12-42, EJ16-14-50, EJ16-18-63 bits, and the EJX16 carbide bit series are not included in sets. These products should be purchased separately.

Inserts

Material	Steel	●	
	Stainless Steel	●	
Cast Iron	●	●	
Aluminium			●
Titanium Alloy, Heat Resistant Alloy			●

Insert with large nose radius have a stronger cutting edge, and are therefore ideal for large diameter boring of short holes. Small nose radius insert is ideal for smaller diameter boring or finishing.

Boring head type	Dimension	Code No.	Grade	Cermet (w/o coating)	Carbide K
			Material	T	F
			NOSE R	NX	HTI
EJ16-6-21 EJX16-6-45 -8-28 EJX16-8-60		EM02-○2 EM02-○4	0.2	●	●
			0.4	●	●
EJ16-10-35 EJX16-10-75 -11-40 -12-42 -14-50 -16-50 -18-63 -22-68 ECC-28-10 -36-11.5 -12-90 -14-105 -16-120		EM09-○2 EM09-○4	0.2	●	●
			0.4	●	●
ECC-54-19		EM11-○2 EM11-○4	0.2	●	●
			0.4	●	●

★Minimum order quantity : 10pcs

★When you use the other brand insert, use same brand Clamp bolt.

Code No. of ISO standard Insert Tip

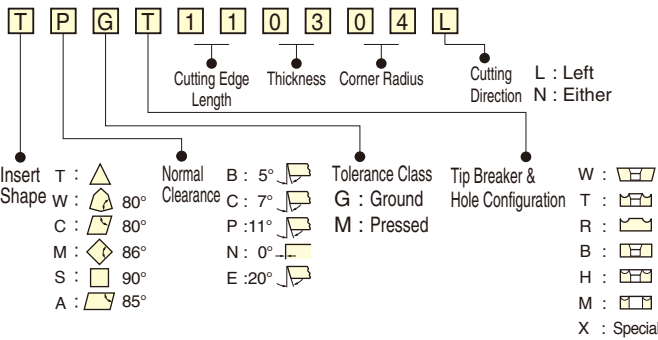

Please add the grade indication into ○, and add the insert tip material indication at the end of the Code No.
e.g. EM09-T4(NX)

Grade & Material

Grade	Grade Indication	Insert Tip Material Indication	Specification
Cermet (w/o coating)	T	NX	The general material for the steel and the cast iron with the heat resistance and the toughness.
Carbide K	F	HTI	Toughness and the excellent wear resistance. Applicable for the cast iron, non-ferrous metal and the non-metal.

Recommended Cutting Speed ○...Best ○...Good —...Unsuitable

Insert		SS41	S55C	SCM	SKD	SC	FC,FCD	SUS	ALC	Ti
Code No.	Material									
T	NX	100~300	100~300	100~300	80~150	80~150	150~160	80~150	-	-
F	HTI	-	-	-	-	-	60~130	-	300~500	30~40

★The cutting speed is recommended to be reduced to 50% for the interrupted cutting. ★Rapid speed : ~6000min-1.
 ★Please be sure to make a test run and confirm of no deflection, vibration and unusual sound.

Recommended Cutting Condition(removal,feed)

Boring Range	Boring head type			Best Condition		MAX. Condition	
	Boring bit	Solid carbide bit	Cartridge	Removal mm/φ	Feed mm/rev	Removal mm/φ	Feed mm/rev
φ 6~ 12	EJ16- 6-21 - 8-28	EJX16- 6- 45 - 8- 60		0.1~0.2	0.03~0.07	-	-
φ 10~ 30	EJ16-10-35 -11-40 -12-42 -14-50 -16-50 -18-63 -22-68	EJX16-10- 75 -12- 90 -14-105 -16-120		0.1~0.3	0.05~0.07	-	-
φ 28~ 56			ECC-28-10 -36-11.5	0.2~0.4	0.05~0.08	1.0	0.1
φ 54~200			ECC-54-19	0.2~0.5	0.05~0.08	2.0	0.15

$$\text{Speed } n(\text{min}^{-1}) = \frac{V_c \cdot 1000}{\pi D}$$

Vc: Cutting Speed(m/min)

π : 3.14

D : Boring dia(mm)

f : Feed(mm/rev)

$$\text{Feed } V_f(\text{mm/min}) = n \cdot f$$

$$\text{Logical Surface Finish (min)} = \frac{(\text{Feed per rev.})^2}{8 \times \text{Nose/R}}$$

Feed per rev. depends on Nose/R and accuracy required.

eMAC Boring Set



* Photo Shows S.EMAC6110

φ 6 ~ 110 eMAC Boring Set

Code. No.	Part name	Code No.	Q'ty	Weight (Kg)
S.EMAC6110	eMAC Boring Head	Q26-EMAC6110-61	1	0.85
	Boring Bit	EJ16-6-21	1	0.04
		EJ16-8-28	1	0.04
		EJ16-11-40	1	0.06
		EJ16-16-50	1	0.07
		EJ16-22-68	1	0.1
	Extension Bar for Cartridge(S/M)	ECCB-53	1	0.5
	Cartridge	S ECC -28-10	1	0.01
		M ECC -36-11.5	1	0.02
		L ECC -54-19	1	0.08
	Bush	ECC -54-BM10	1	0.02
	Plate for Cartridge	ECCP-14	1	0.2
	Counter Weight for Large Dia.	ECC-92-CW	1	0.5
	Insert Tip	EM02-T2(NX)	2	—
		EM09-T2(NX)	5	—
		EM11-T2(NX)	1	—
	Tip Clamping Bolt / Spare	TS21	1	—
		TS211	1	—
CS250T		1	—	
CS300890T		1	—	
Wrench Set		1	—	
Case		1	—	

★Base Holder for eMAC Boring Head is available as an option. Please refer P.93

★Please refer P.95 for Insert Tip.

★Gross weight : 2.9kg Case Size : 330x290x120

eMAC-W Boring Set

φ 85 ~ 200 eMAC-W Boring Set Parts List

Code. No.	Part name	Code No.	Q'ty	Weight (Kg)
S.EMAC6200 -W85200	eMAC-W Boring Head	Q42-EMAC6200W-85	1	3.4
	Cartridge(L)	ECC-54-19	1	0.08
	Plate for Cartridge(L)	ECCP-23	1	0.4
		ECCP-23L	1	0.6
	Counter Weight for Large Dia.	ECC-92-CW	1	0.05
	Insert Tip	EM11-T2(NX)	1	—
	Tip Clamping Bolt / Spare	CS300890T	1	—
	Wrench Set		1	—
Case		1	—	

★Base Holder for eMAC-W Boring Head is available as an option. Please refer P.94

★Please refer P.95 for Insert Tip.

★Gross weight : 5.7kg Case Size : 330×290×120

eMAC Boring Head / Combination of Processing Each Dia.

