

# CNCB350, 450(T), 630

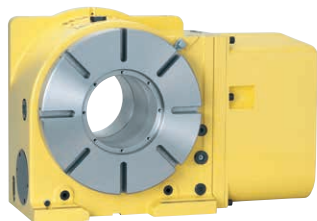

External dimensions depend on the type of the servo motor. Indicated dimensions are in case of FANUC. Please contact us for CAD files (2D:DXF, 3D:PARASOLID).

## CNCB350



### Ultra Big Bore ( $\phi 154\text{mm}$ ) Specification

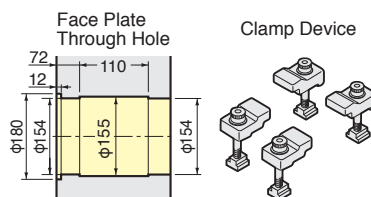
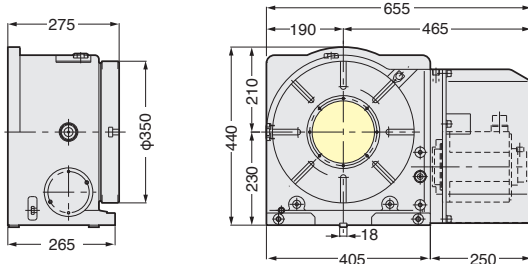

## CNCB450

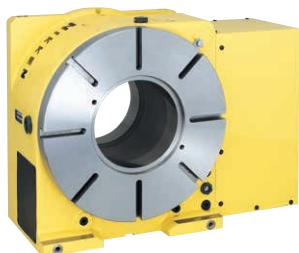

### Ultra Big Bore ( $\phi 205\text{mm}$ ) Specification

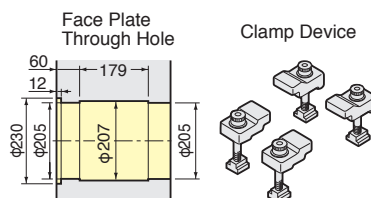
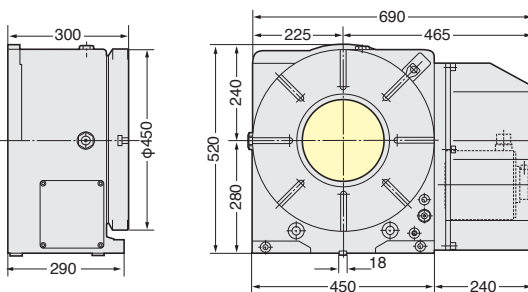

## CNCB450T



### Ultra Big Bore ( $\phi 205\text{mm}$ ) Specification

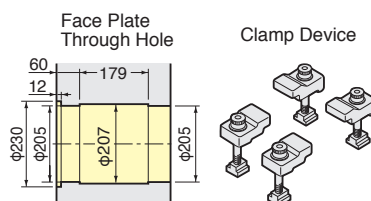
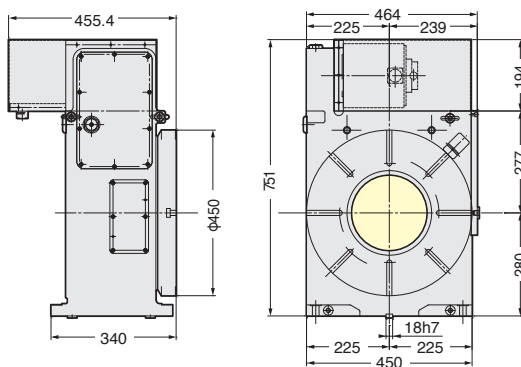

## CNCB630

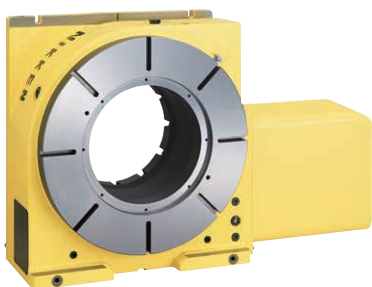

### Ultra Big Bore ( $\phi 345\text{mm}$ ) Specification

